

---

# Cavity wall & Ceiling Installation

using the BackboxCV 345/300/200



*amira*®  
THE INVISIBLE SPEAKER CO.

---

# Caution: Read before installing this product

This manual contains detailed instructions required to install your Amina Invisible Loudspeaker using this Backbox. It should be read in consultation with the Amina Invisible Loudspeaker installation guide.

**Please read carefully before installing this product.**

- To ensure correct installation, please read this guide carefully and keep in a safe place for future reference.
- Install this product in a cool, dry, clean place - away from direct sunlight and heat sources, vibration, chemical fumes, dust and moisture (steam).
- Do not clean this product with chemical solvents as this may cause damage to the finish. Use a clean, dry or damp cloth.
- Ensure that all installation mounting surfaces are able to support the weight of the BackboxCV with that of your chosen speaker.
- Do not attempt to modify or repair the product. Contact your distributor or manufacturer if it is faulty or damaged in any way.
- You will require a minimum cavity depth of 75mm (3") behind the plasterboard to allow the use of product.



## ENVIRONMENTAL:

*Please be aware that this product significantly reduces the rearward airborne sound output of an Amina Invisible loudspeaker. Impact borne vibrational energy may still travel some considerable distance up, down and along the wall or ceiling structure. It is therefore recommended that this product be fitted within acoustically isolated stud walls or ceilings where possible.*



## WARNING:

*No attempt should be made to install this product within existing building structures unless you are certain that no electric cables, water pipes, gas pipes or supporting joists will be cut through.*



## Safety Hook:

*The BackboxCV is equipped with a tether point if a safety hook is required to be fitted.*

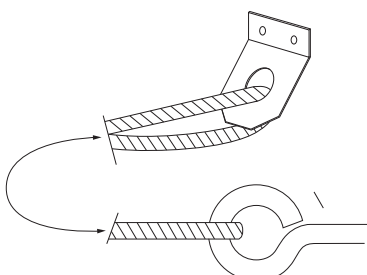

---

# Contents

- 01 Packaging / Introduction / Overview
- 02 Installation steps 1 & 2
- 03 Installation steps 3 & 4
- 04 Installation steps 5 & 6
- 05 Installation steps 7, 8 & 9
- 06 Alignment and plastering preparation - retrofit patch technique
- 07 Alignment and plastering preparation - retrofit feather technique
- 08 Alignment and plastering preparation - full wet skim
- 09 Alignment for patch plastering (drywall)
- 10 Alignment for feathered skim (drywall)
- 11 Plastering and Decorating
- 12 Plastering and Decorating Continued
- 13 Warranty Information

---

## Correct Fixing Method

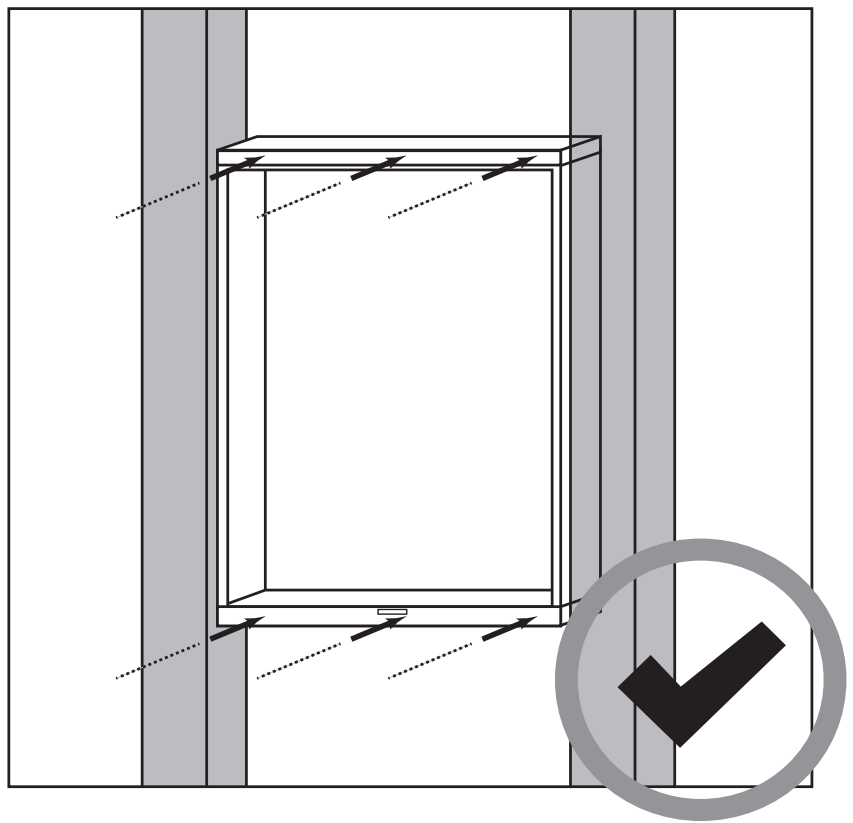
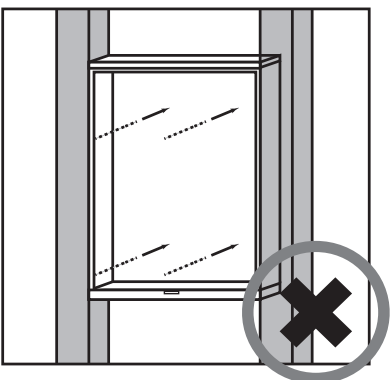
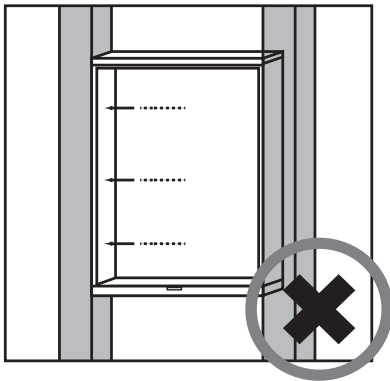

**IMPORTANT:** The BackBox **must** be fixed to the plasterboard only. **Never** attach directly to the stud work or near supporting structure.

---

# Packaging



## CAUTION:

Take care when removing the BackboxCV from the carton.

The packaging for the BackboxCV has been carefully designed to protect the product during transit. Please retain it in the unlikely event you need to return the product to your dealer or manufacturer. Please recycle the packaging should you wish to dispose of it.

The BackboxCV outer carton is made up of 80% recycled single wall board.  
The BackboxCV is formed from a fully recyclable aluminium enclosure.

## Introduction

Thank you for purchasing the Amina Technologies BackboxCV. This product has been designed to enhance the installation of your Amina Invisible loudspeakers by providing an optimised enclosure for them to operate in. The BackboxCV provides 17dB SPL reduction from 200Hz and above (-25dB at 1kHz) of an Amina Invisible loudspeaker's rearward airbourne sound output into the wall or ceiling cavity.

Please note that the BackboxCV does not reduce mechanical impact type sound transmission in a building. This can only be achieved by installing the product in mechanically/acoustically isolated stud walls and ceilings. Please contact Amina for further advice.

The BackboxCV is relatively simple to install and this guide includes step by step instructions on the correct way to do this in order to align the Amina Invisible Loudspeaker ready for plastering.

## Overview

- ① Fold out support tabs
- ② Rubber grommet
- ③ Speaker mounting flange
- ④ Backbox mounting flange
- ⑤ Soundproofing layer
- ⑥ Speaker fixing holes

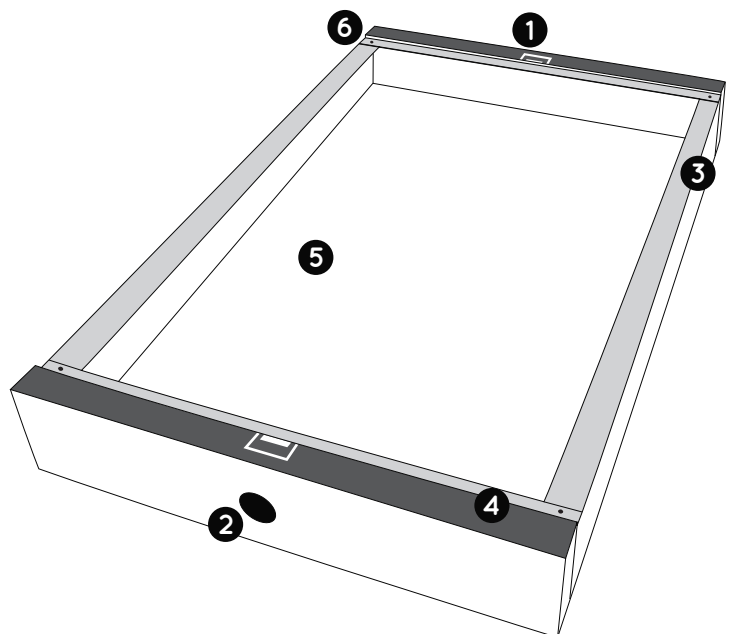

## BackboxCV installation

### 01 Locate joist work

When you have chosen your speaker locations, before cutting a hole in the plasterboard it is important that you locate the position of the wall studs. Ensure the spacing between them is at least 5mm (3/16") greater than the width of your Amina speaker for a portrait orientated speaker.

If necessary cut an inspection hole in the plasterboard, use a tape measure inserted through the hole to accurately locate the edges of studs

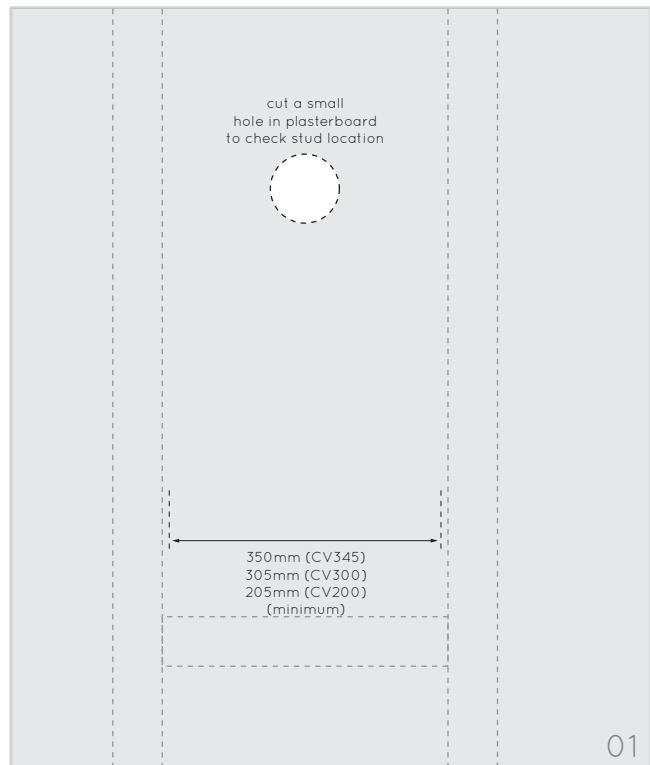

### 02 Using the Cutout Template for pre-install

Staple or tape to plasterboard/drywall to act as a template.

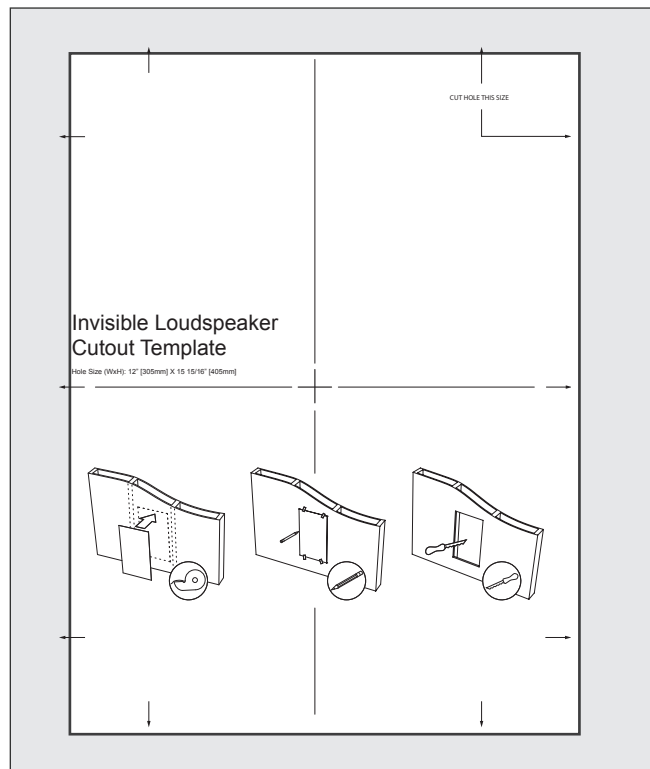

## Fitting the BackboxCV

03

### BackboxCV installation continued...

#### 03 Using the Cutout Template

1. Ascertain joist position behind plasterboard/ drywall.
2. Ensure cut out dimensions fit between the joists.
3. Use a knife to cut around the outside of the template.

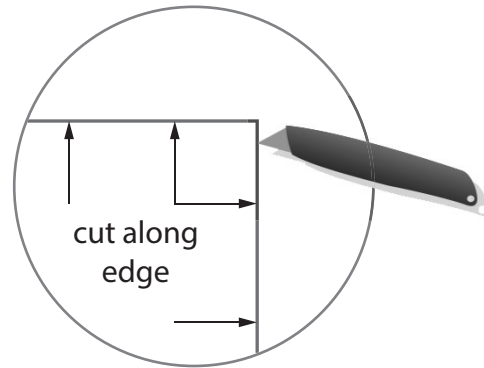

#### 04 Check which version of the BackboxCV you have before following this section

Create 455 x 205mm (17 <sup>7</sup>/<sub>8</sub>" x 1 <sup>1</sup>/<sub>8</sub>") aperture (CV200)

Create 405 x 305mm (15 <sup>7</sup>/<sub>8</sub>" x 12") aperture (CV300)

Create 455 x 350mm (17 <sup>7</sup>/<sub>8</sub>" x 13 <sup>3</sup>/<sub>4</sub>") aperture (CV345)

Using a sharp knife or pad saw, cut an aperture in your plasterboard wall or ceiling. Ensure the aperture is created between supporting joists or stud work.

We strongly advise that joists are not cut to make space for the backbox. Any activity of this sort may well influence the structural integrity of your property.

**Important: Double check the size of the aperture, as this is important further on into the installation process.**

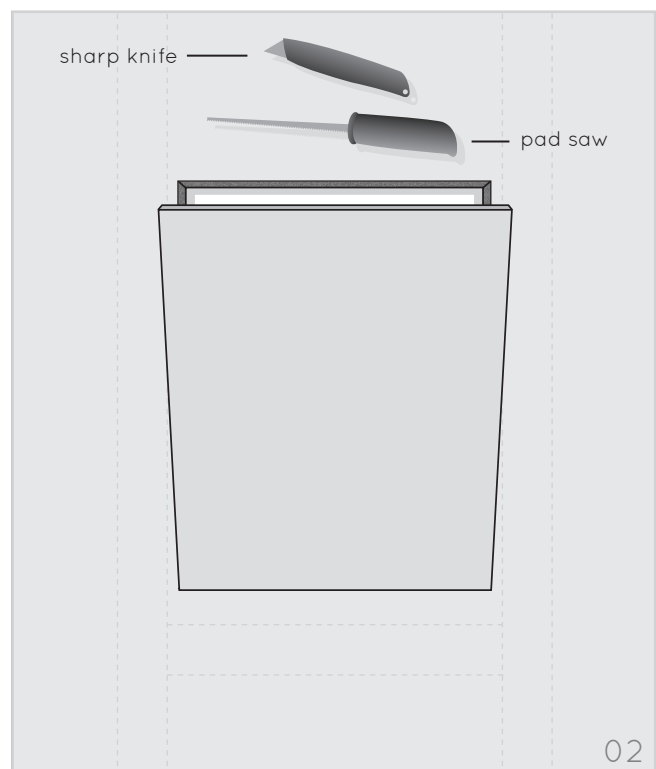

## BackboxCV installation continued...

### 05 Locate cable and position BackboxCV

Pull the speaker cable through the rubber grommet in the top side of the BackboxCV and ensure speaker cables are pulled through with a manageable length available. Doing this will make it easier to connect the cable to the speaker later on in the installation process.

Position the BackboxCV within the aperture so as to rest it against the rear side of the plasterboard.

Use the fold out tabs at either end of the backboxCV to help support it in position before securing it to the plasterboard.

A 75mm (3") cavity depth is required to fit a BackboxCV.

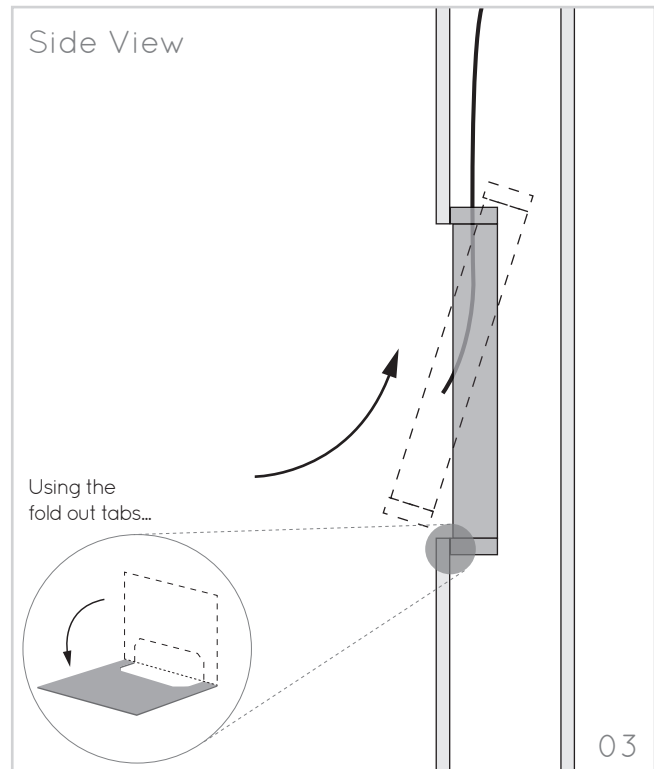

### 06 Fix BackboxCV and insert insulation

Using 8 fine thread buggle head drywall screws (4 at each end) fix the BackboxCV by screwing through the plasterboard and self tapping into the backbox mounting flange **4**. When positioned correctly, the backbox's speaker mounting flange **3** with soft foam surface should be visible along all four sides of the aperture.

It is recommended to add sound absorbing mineral wool inside the surrounding cavities to further reduce sound transmission behind the speaker.

Front View

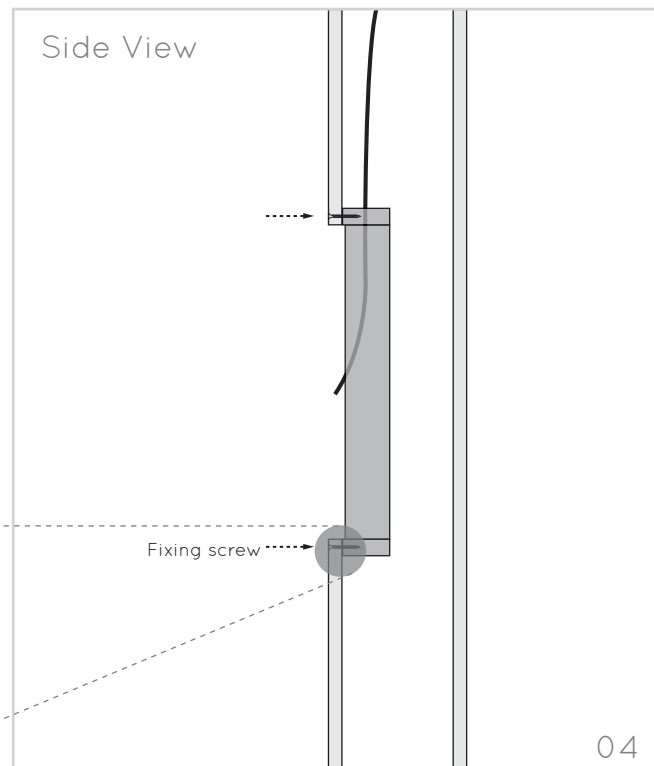
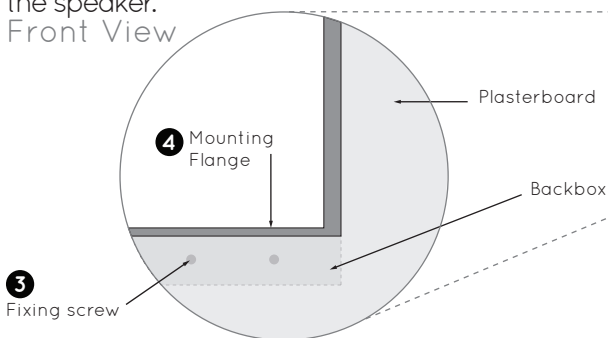

## BackboxCV installation continued...

### 07 Fixing the speaker to the BackboxCV

Once the speaker has been electrically connected it can now be fixed to the BackboxCV.

With the speaker resting on the speaker mounting flange **3** use the flange head screws provided to secure the speaker onto the BackboxCV by self tapping into the speaker mounting flange **3**, through the speaker fixing holes **6**.

Ensure the speaker face is aligned correctly (see alignment section, pages 6 - 10) and that everything is firmly held in position. Shims may be necessary.

Amina backboxes (BackboxCV) are designed for 12.5mm (1/2") plasterboard. Shims can be supplied to adapt the backboxes for different plasterboard thicknesses. Contact your supplier when ordering.

For plasterboard *thicker* than 12.5mm (1/2") fit shims between speaker and speaker mounting flange **3**.

For plasterboard *thinner* than 12.5mm (1/2") fit shims between the back of the plasterboard and the backbox mounting flange **4**.

### 08 Testing

Speaker testing should be done before plastering. For information on speaker testing please refer to your Amina Invisible Loudspeaker installation guide (Section C)

### 09 Plastering

Please refer to pages 11 and 12 for details on how to plaster your loudspeaker after you have installed the BackboxCV and speaker.

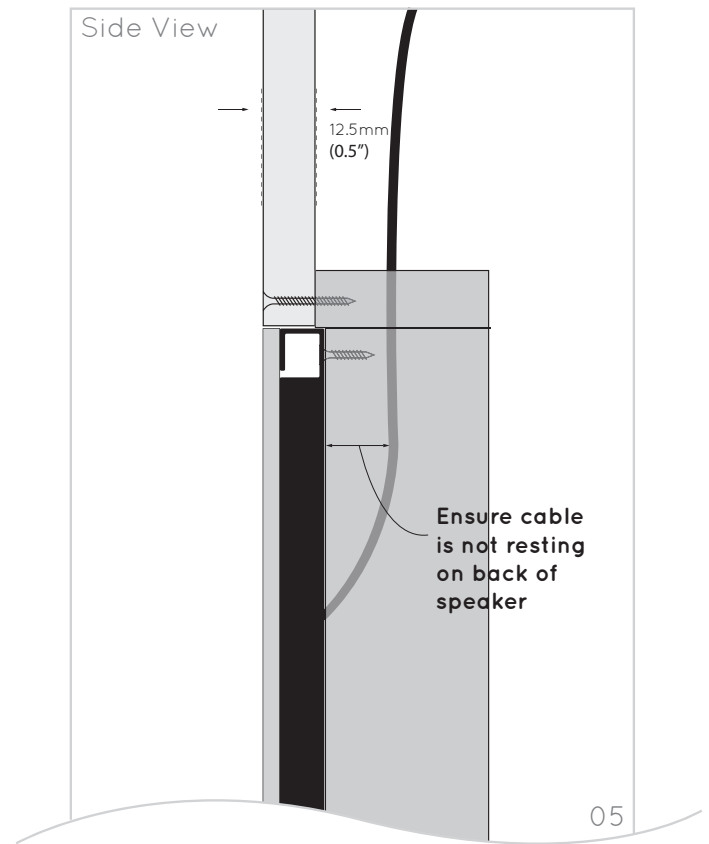

For plasterboard thicker than 12.5mm (1/2")  
Shim adhered to speaker

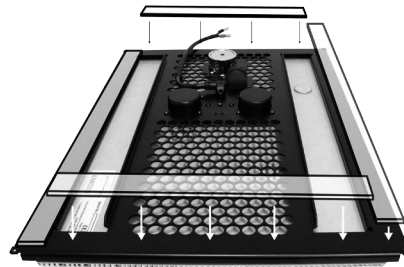

For plasterboard thinner than 12.5mm (1/2") Shim adhered to Backbox

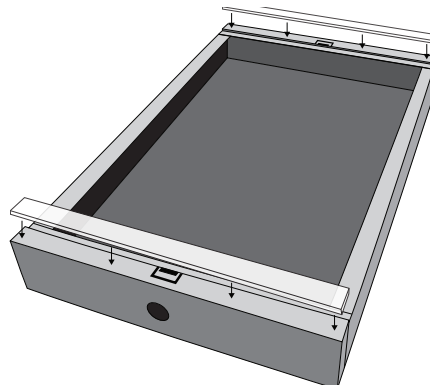

The following section of this guide shows how to align the BackboxCV for the different plastering techniques that can be used.



## Retrofit / pre-skimmed plasterboard Patch plastered finish

*For walls / ceilings that have already been plastered.*

### BackboxCV alignment required for plastering

After removing a 25-50mm (1" - 2") wide section of existing plaster surrounding the cut out, the front face of the speaker should be positioned 2mm (3/32") back from the finished plaster surface. Use shims if required.

### To patch plaster:

Skim across the speaker front and bond with the existing finished plaster. Amina recommend British Gypsum Easi-Fill® which allows a smooth accurate finish using fine sandpaper or a wet sponge.

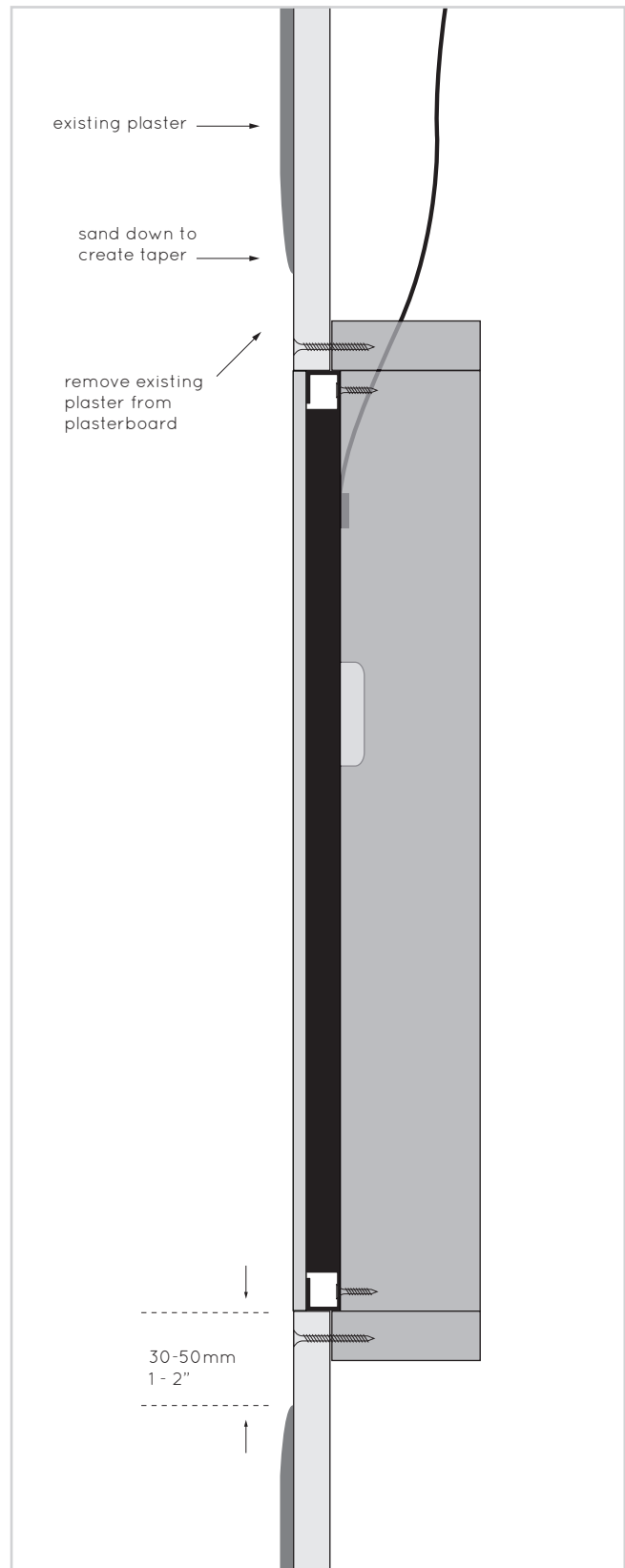
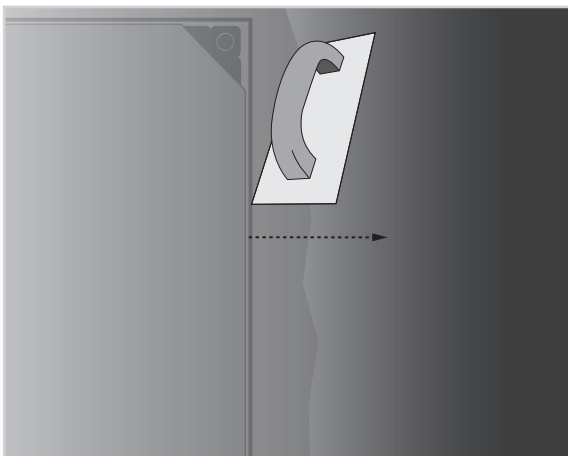

## Retrofit / pre-skimmed plasterboard

### Feathered skim finish

*For walls / ceilings that have already been plastered.*

#### BackboxCV alignment required for plastering

Using a 2-3mm (3/32") shim set (contact your Amina supplier) between the back of the speaker and the speaker mounting flange ③, the front face of the speaker should be flush with the front face of the existing painted/plastered wall/ceiling.

The shim kit should match the plaster thickness on your wall/ceiling.

#### To feather finish

Allow much larger area around the speaker (approx. 1m<sup>2</sup> (10 feet<sup>2</sup>) to be skimmed. This 2mm (3/32") thick skim is then feathered outward at the edges and blended into the existing wall/ceiling finish.

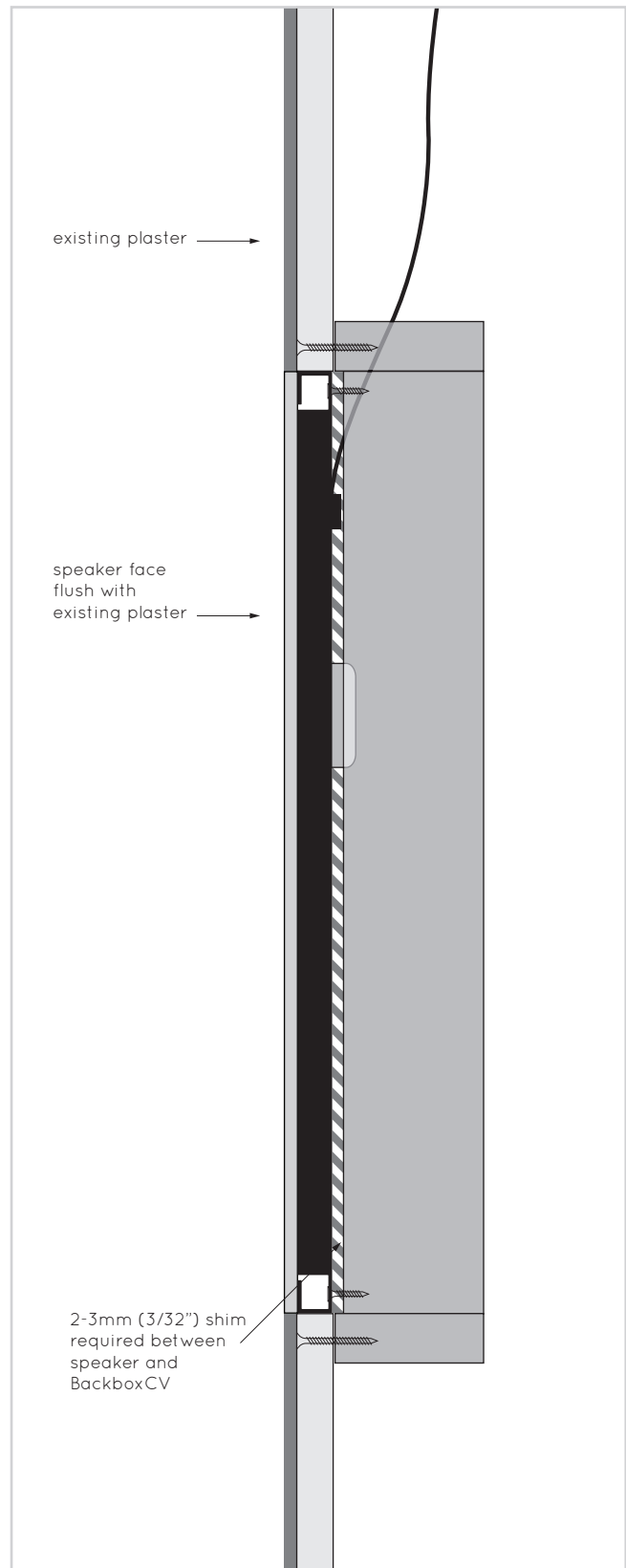

# New build / new plasterboard

## Full wet skim finish

*For new plasterboard walls / ceilings that have not yet been plastered.*

### BackboxCV alignment required for plastering

The front face of the speaker should be flush with the face of the new wall/ceiling if the BackboxCV has been correctly installed.

This method positions the speaker to be skim plastered over during the process of the entire wall/ceiling being plastered. Apply no more than 2mm (3/32") of plaster over the Loudspeaker surface.

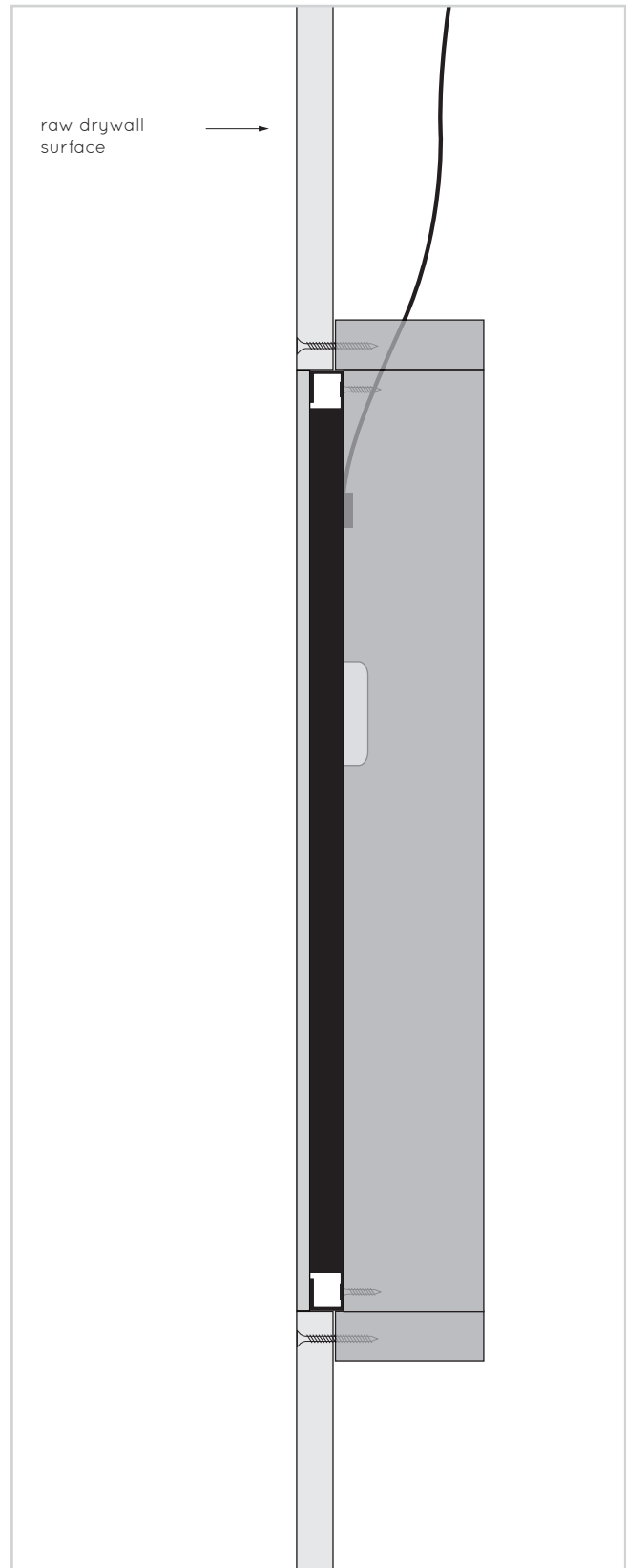
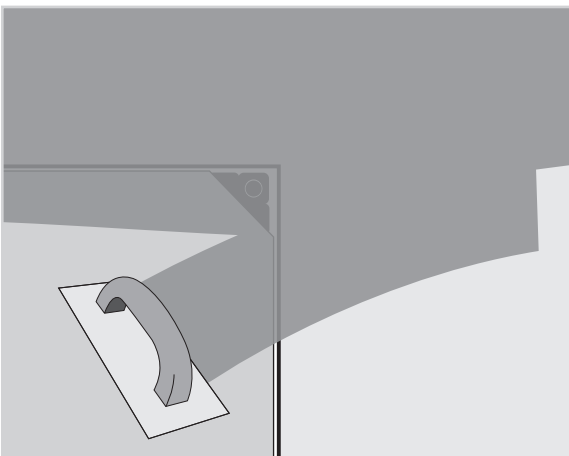

## Retrofit / new drywall Patch plaster finish

*For new drywall walls / ceilings that will be taped and joined.  
(North American construction)*

### BackboxCV alignment required for plastering

The front face of the speaker should be located 2mm (3/32") behind the face of the new wall/ceiling if the BackboxCV is correctly installed.

This method positions the speaker to be patch plastered with a 2mm (3/32") skim across the speaker front and blended with the drywall.

Amina recommend British Gypsum Easi-Fill® which allows a smooth accurate finish using fine sandpaper or a wet sponge.

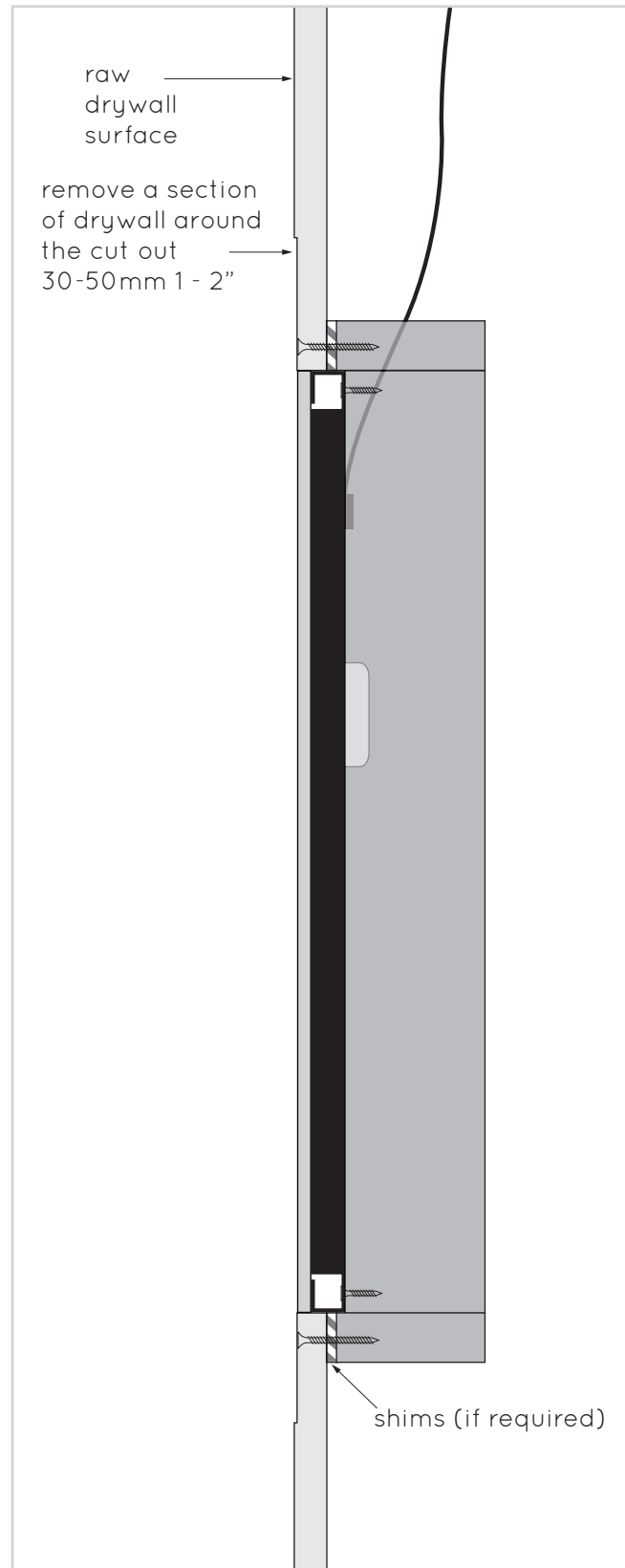
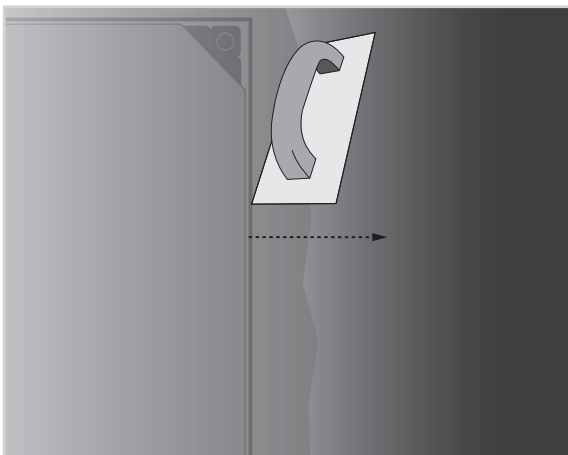

# Retrofit / new drywall

## Feathered skim finish

*For new drywall walls / ceilings that will be taped and joined.*

*(North American construction)*

### **BackboxCV alignment required for plastering**

The front face of the speaker should be flush with the face of the new wall/ceiling if the BackboxCV is correctly installed.

This method positions the speaker for a large area (approx. 1m<sup>2</sup> (10 feet<sup>2</sup>)) to be skimmed over it. This 2mm (3/32") thick skim is then feathered outward at the edges and blended into the existing wall/ceiling finish.

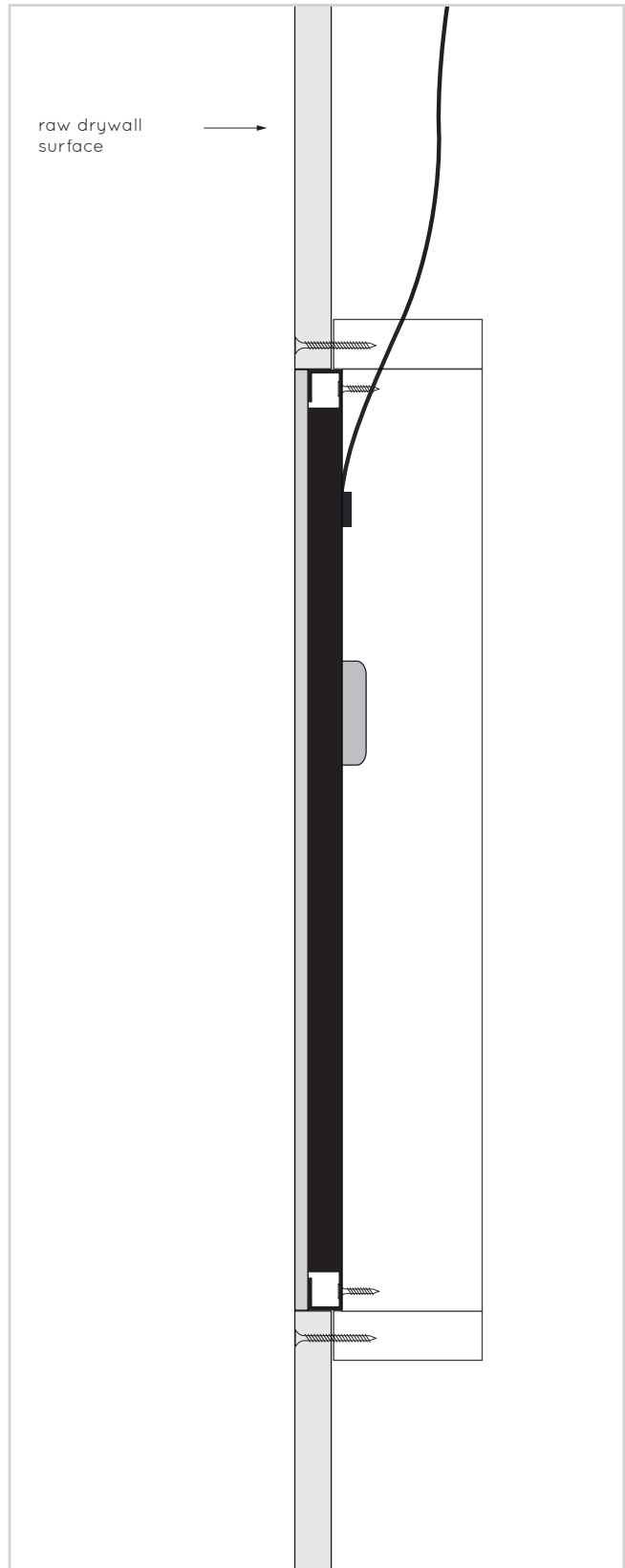

## Plastering and decorating

### 01 Fill gap between speaker and surrounding area

It is important to ensure that plaster is pushed into the 2mm (3/32") gap that surrounds the speaker. This will create a strong bond between the edge of the speaker and the edge of the plasterboard or render and helps prevent any cracks appearing in the final skim finish.

Use a low shrinkage repair plaster such as British Gypson Easi-Fill®.

**IMPORTANT: There MUST be a gap of 2mm (3/32") all the way around the speaker edge. If there isn't simply remove the speaker and increase the aperture size accordingly.**

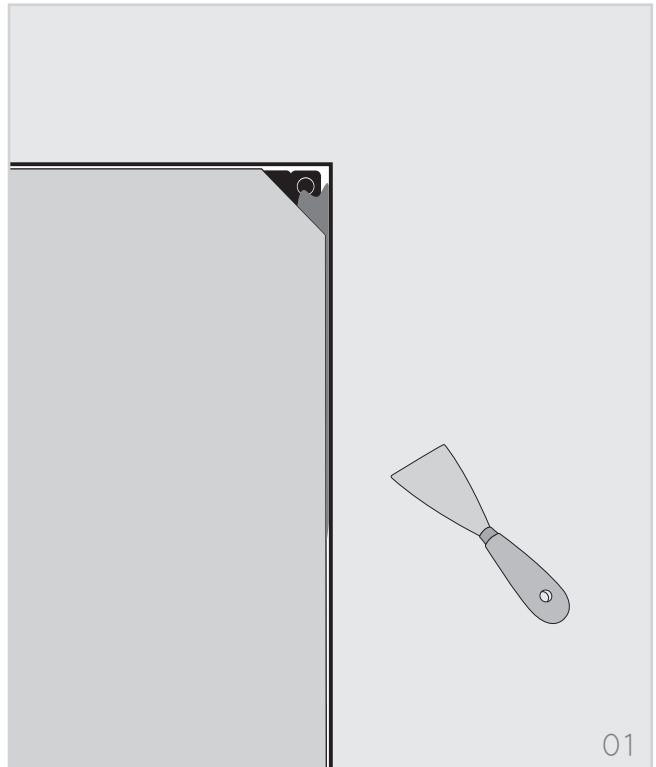

### 02 Clean Speaker Surface

Clean speaker surface of dust and grease with a solvent wipe or damp (not wet) cloth. Ensure that silicone sources have not been used in the vicinity.

### 03 Apply joint tape

Apply professional plasterboard self-adhesive fibreglass joint scrim to the speaker face. Ensure it covers the entire speaker face and the plasterboard joint.

Amina can provide rolls of 500mm (20") wide adhesive scrim to do this in one operation. Alternatively, use multiple strips of narrower scrim tape.

This provides increased surface area for the plaster skim coat to bond to the panel surface.

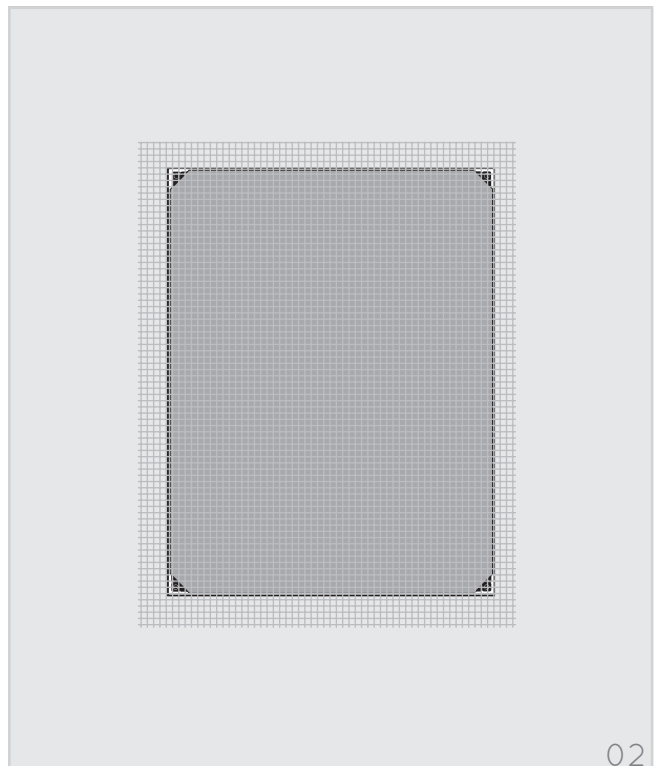

## Plastering and decorating continued...

### 04 Plastering

Use standard finishing plaster for large areas. For patch plastering use a low shrinkage repair plaster such as British Gypsum Easi-Fill®

**Important: To ensure proper operation and sonic performance, no more than 2mm (3/32") of plaster must be applied to the surface of the panel.**

**The working environment must be dry enough to allow the plaster finish coat to dry within hours, not days.**

### 05 Decorating

Allow your plasterwork to dry completely. Test the speaker again. You can then paint the surface or hang wallpaper in the usual manner.

Amina Invisible speakers have been optimised for three coats of emulsion once plastered. Additional coats will cause very small reductions in the maximum sound pressure levels achievable.

Completed and fully dried plaster surfaces should be finished with permeable coatings / materials to allow moisture in that coating or the adhesives used to apply those materials, to dry into the environment quickly.

Oil based coatings and other non-permeable surfaces will trap moisture in the plaster surface for many days and even weeks. This has the potential to work its way back to the Amina loudspeakers exposing them to an unacceptably damp environment for an extended period.

The use of impermeable coatings and materials should be considered carefully and with caution. Bare plaster surfaces must be pre-treated with a primer / sealing coat that is permeable during its drying process. The entire surface must then be fully dry (this may take some weeks) before applying the impermeable coating or material.

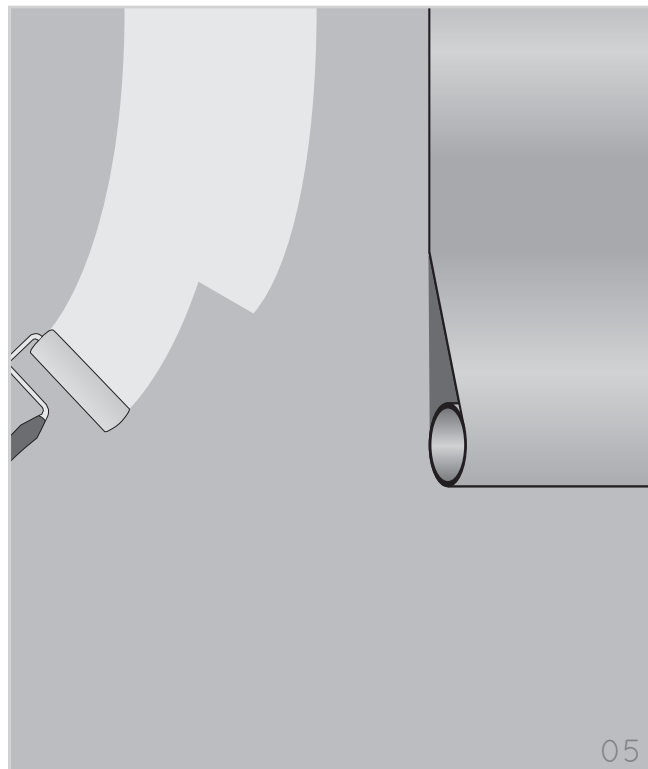

#### Note:

**Amina have separate guides for information about installing the product behind other materials and surfaces such as wooden panels, acrylic and melamine (Formica®).**

**Contact Amina if you require any of this additional information.**

---

## Warranty information

### Limited Warranty:

The Amina BackboxCV is designed to last for many years. Correctly installed in accordance with these instructions, Amina warrants the BackboxCV against defective materials and workmanship for a period of five years in commercial applications and ten years in residential applications.

At the end of the product's useful life it should be recycled in a responsible manner. The majority of the product is aluminium, a valuable asset. If you have any questions please contact Amina Technologies Ltd.



\* Please refer to our full warranty statement for details, available on our websites, or alternatively contact us via email on any of the above addresses.

**Important Note:** This product is not certified to European Construction Products Directive EN 54-24 and therefore must not be used in European voice evacuation systems.

---

## Copyright information

This document is Copyright of Amina Technologies Ltd, 2016  
 Easi-Fill is a registered trademark of British Gypsum Ltd  
 Amina is a registered trademark of Amina Technologies Ltd

---

## Contact information

### Amina Technologies Ltd

Cirrus House, Glebe Road, Huntingdon  
 Cambridge, PE29 7DL, UK  
 T: +44 (0) 1480 354390  
 E: inspired@amina.co.uk  
 W: www.amina.co.uk

### North America

Direct 503.256.2600  
 Toll free 1-800.666.6316  
 Fax 503.256.5966  
 E: salesna@amina.co.uk

The logo features the word 'amina' in a lowercase, cursive script font, with a registered trademark symbol (®) to its upper right.

---

THE INVISIBLE SPEAKER CO.

---