

# Architectural

Speakers & Electronics Product Guide



# Introduction

Monitor Audio's Architectural speakers and amplifier solutions are designed and engineered to support the demands of the installer: reliability, flexibility, usability, intuitive functionality, easy integration, superior build quality and outstanding sound performance.

A varied portfolio of high-performance models, each is born of Monitor Audio Group's Transparent Design Philosophy, where each individual product is the result of intense collaboration between R&D, drawing on decades of experience within the design team and ensuring that all the elements of performance, technology and design work in harmony. One is never allowed to overpower the other and each plays a vital role in delivering on our promise of musical neutrality and acoustic transparency.

Listen Again.

Explore our Architectural Speaker & Electronic range at [monitoraudio.com](https://monitoraudio.com)



Monitor Audio offers a Lifetime Warranty on most products in the Architectural speaker range. For warranty periods of cover, please refer to each product's page at [monitoraudio.com](https://monitoraudio.com)

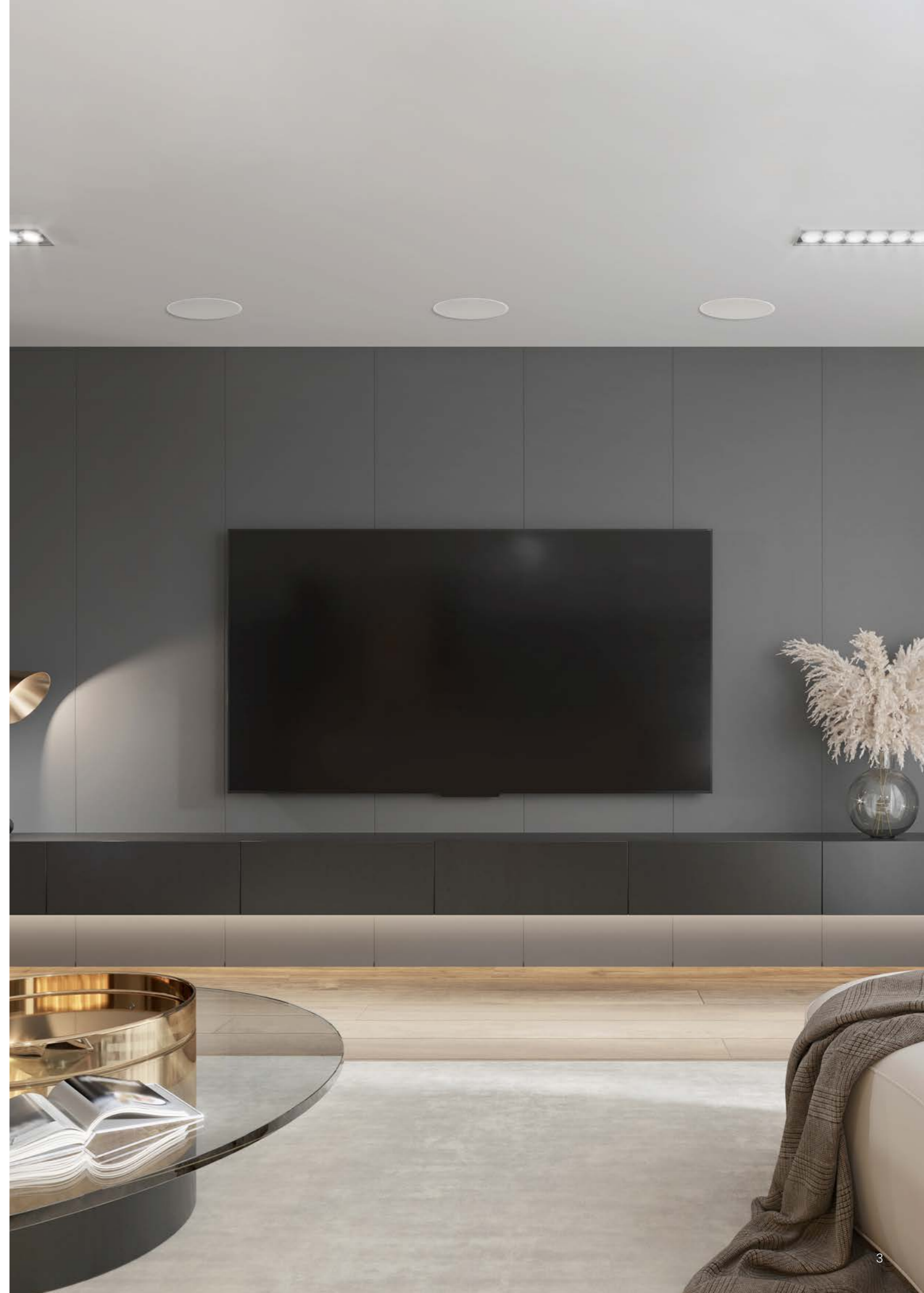



# Contents

**6**

Creator Series

**26**

Cinergy

**32**

Anthra Subwoofers

**36**

Platinum

**44**

Weather Resistant

**58**

Specialist

**66**

Custom Subwoofers

**70**

Streamers & Amplifiers

**76**

Soundbars

**80**

SoundFrame

**86**

Basics

**89**

Accessories

**90**

Specifications





# Creator Series

## British High-Fidelity Architectural Sound Redefined

The Creator Series re-writes the rules of custom installation. A smart, tiered range of high-performance, installer-friendly in-ceiling and in-wall loudspeakers that delivers better sound for customers, and enhanced flexibility and clarity for installers.

The application of key Monitor Audio acoustic technologies more usually found in our premium standalone loudspeakers ensures lifelike, pristine sound, while innovative features and a comprehensive, clearly defined range make for hassle-free installation. If you thought you knew custom installation, think again; Creator Series redefines British high-fidelity architectural sound.

Explore Creator Series  
at [monitoraudio.com](https://www.monitoraudio.com)





# Naming Structure

Creator Series products are named based on their application, technologies, driver sizes and special features.

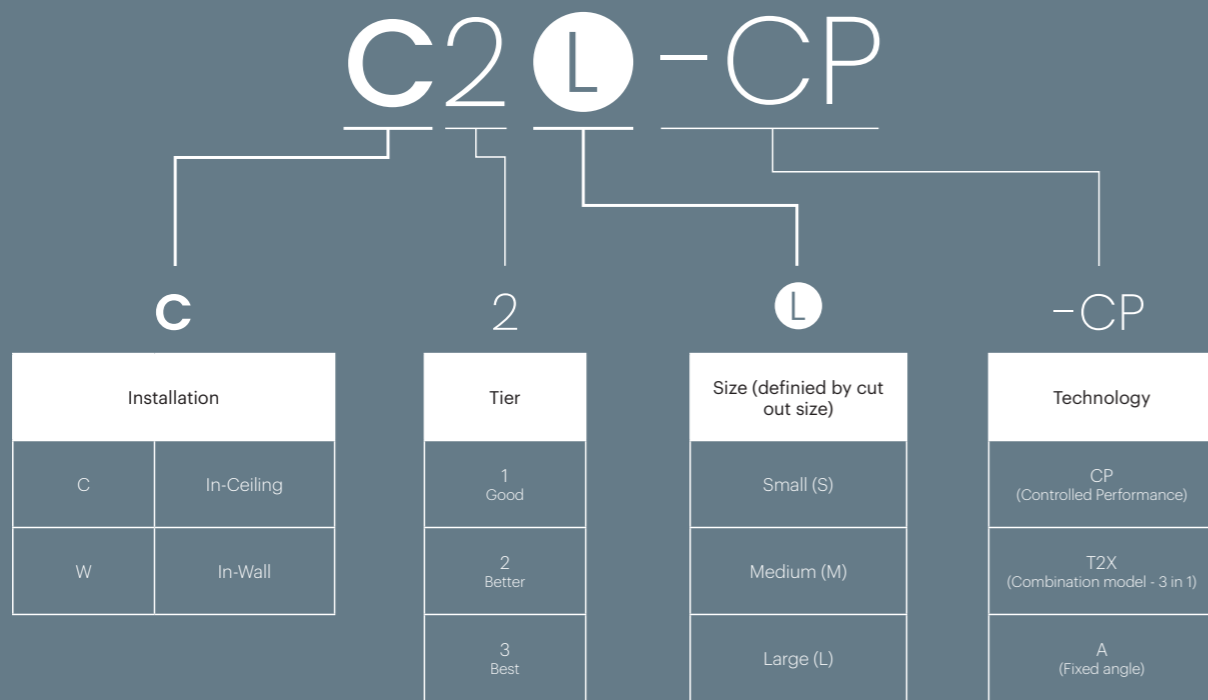

# Common Features

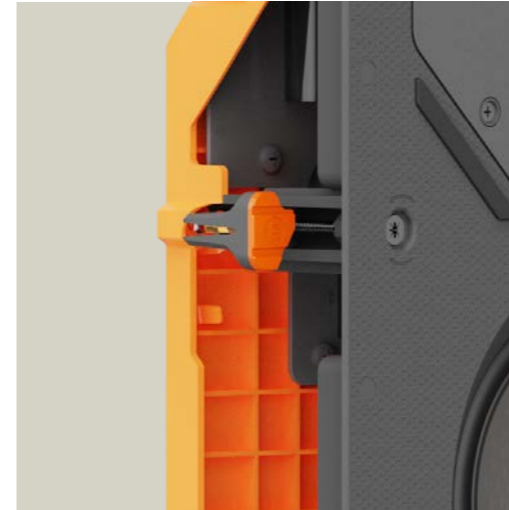

### Tri-Grip II

Tri-Grip II is a new dog-leg mechanism that is considerably stronger and more reliable than the previous generation, meaning both speaker placement and extraction could not be simpler.



### Quik-Link

Our new innovative Quik-Link terminal revolutionises speed of installation. With Quik-Link you can make cable connections up the ladder at pre-installation stage. Once the installation is complete, the terminal, which is now connected with the speaker cables, magnetically snaps and locks into place on the rear of the speaker as you place the speaker into ceiling or wall. It's that easy.



### Controlled Performance (CP)

Controlled Performance (CP) models are fitted with a fully sealed back box that provides an ideal air load for the drivers, optimising mid-range and bass performance while maintaining sonic consistency regardless of interior wall construction. These rigid, mineral filled enclosures reduce the sound from the back of the cabinet by around 30dB. This range guarantees excellent audio quality and versatility, and offers superior sound isolation between rooms and floors.

# Tiers



## Tier 1

A comprehensive range of speakers designed for cost-effective installations where product simplicity and solid acoustic performance is required.

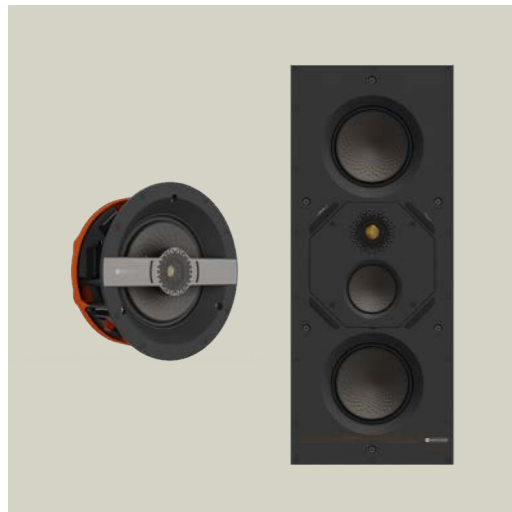

## Tier 2

A range of speakers that have all the engineering qualities of Tier 1, yet offer improved acoustic performance and contain additional features to allow more freedom in speaker placement, such as boundary correction, high-frequency cut/boost, and the dual-stereo T2X.

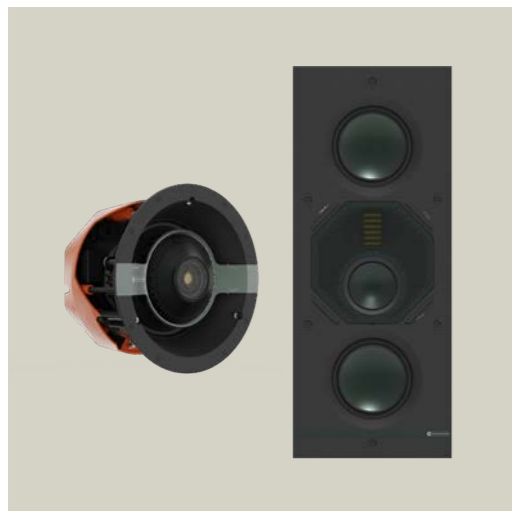

## Tier 3

A high-performance range of speakers that have all the engineering qualities of Tier 2, but offer improved acoustic performance and further features for enhanced speaker placement freedom, such as boundary correction and mid/high-frequency cut/boost, plus leading-edge acoustic technologies.

# Drivers and Tweeters

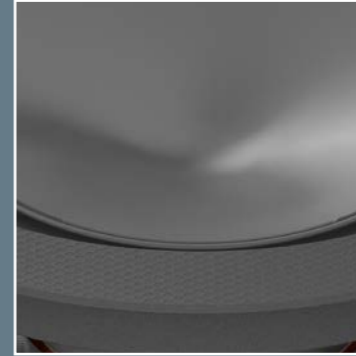

## C-CAM mid-bass drivers

Ceramic-Coated Aluminium/Magnesium (C-CAM) cones have a much higher resistance to bending stress and therefore exhibit much greater fidelity over their entire operating range, producing a smooth transition of frequencies and a sense of realism and cohesion in the soundstage.

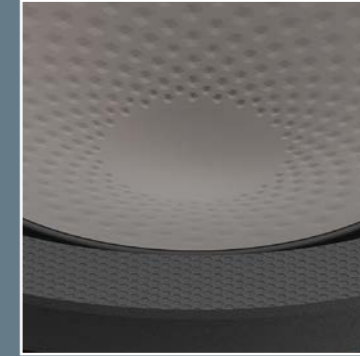

## RST II mid-bass drivers

Rigid Surface Technology II (RST II) cone was developed and perfected using sophisticated computer modelling (Finite Element Analysis). The strengthening effect of RST means that we can use thinner, lighter and more responsive C-CAM cones, providing speed and accuracy with reduced distortion.

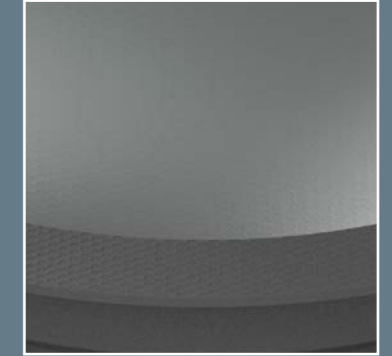

## RDT III mid-bass drivers

Rigid Diaphragm Technology III (RDT III) is a composite 'sandwich' structure made from ultra-thin low-mass skins, bonded to a honeycomb Nomex® core material. It is very light and very strong, meaning that it can respond with great speed without bending - just like a perfect piston.

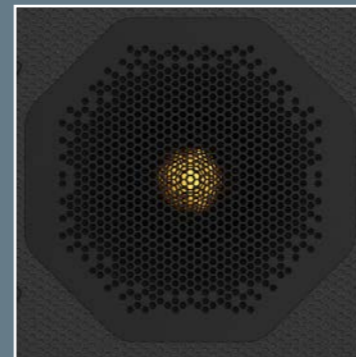

## C-CAM Gold Dome Tweeter

The Gold Dome tweeter is formed from a Ceramic-Coated Aluminium Magnesium alloy, Gold anodised to a specific thickness for ideal stiffness and damping characteristics. Thinner, lighter, more rigid and more efficient than domes made from other materials which are prone to distortion in the audio band.

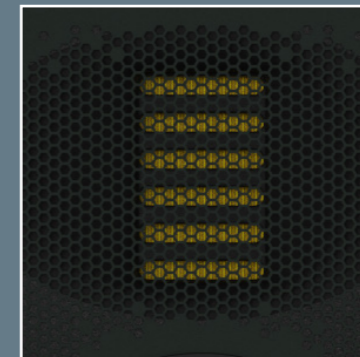

## MPD II Transducer

Tier 3 in-ceiling speakers feature an MPD II high-frequency transducer, developed for the THX® Certified Ultra Cinergy range. The precision specification of the Micro Pleated Diaphragm technology is designed to produce accurate, lifelike sound without any distortion.





## In-Ceiling

The in-ceiling loudspeaker sits at the heart of architectural sound; its ability to fill a room with wonderful sound while remaining virtually invisible delivers on the primary dream of a custom installation audio system.

# Innovative solutions



## T2X

The In-Ceiling T2X is available in medium and large sizes, can be used in 'cinema mono FX', 'mono wide dispersion' and 'single stereo' modes. T2X is ideal used as rear surround channels, Dolby Atmos® systems, within corridors or large areas where maximum coverage is required, and in compact areas where there isn't space to fit two speakers.



## 'A' model

The C3L-A is a new and invaluable addition to the Creator Series. 'A' stands for 'Angle', and the speaker features a fixed-angle IDC II for focused sound, ideal for in-ceiling LCR placement. The fixed-positioned 25 degrees of angle ensures that the linearity of the speaker isn't compromised and provides impressively wide dispersion into the listening area.

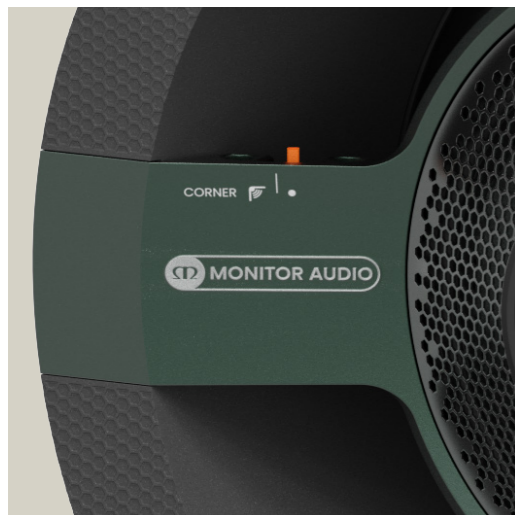

## Boundary EQ

All the Creator Series in-ceiling models perform exceptionally well in a variety of locations, including when close to secondary walls. However, as you move up through the tiers, the models feature enhanced technologies such as boundary correction and high and mid-frequency cut/boost that allows them to be placed in trickier locations such as corners. Because sound performance shouldn't be compromised by placement.

# Sizing

The Creator Series features small, medium and large in-ceiling models. Each size is defined by a cut-out dimension that allows installers to select the perfect array of speakers for your space.



Cut-out dimensions:  
Ø 171mm / 6<sup>3</sup>/<sub>4</sub>"

Driver size:  
5"



Cut-out dimensions:  
Ø 212mm / 8<sup>3</sup>/<sub>8</sub>"

Driver size:  
7"



Cut-out dimensions:  
Ø 248mm / 9<sup>3</sup>/<sub>4</sub>"

Driver size:  
9"



### C1S

<b>Drive Units Complement</b>	5" (127 mm) C-CAM mid-bass driver 1" (25 mm) C-CAM tweeter
<b>Nominal Impedance</b>	8 Ohms
<b>Amplifier Requirement</b>	25 - 100 W
<b>Continuous Power Handling</b>	50 W
<b>Sensitivity (2.83v @ 1m)</b>	84 dB
<b>Cut Out Size</b>	Ø 171 mm (6 3/4")
<b>Mounting Depth</b>	99 mm (3 7/8")
<b>Dimensions (Ø x D) inc. grille</b>	Ø 201 x 103 mm (Ø 7 15/16 x 4 4/16")
<b>Weight</b>	1.4 kg (3 lb 1 oz)



### C1M

<b>Drive Units Complement</b>	7" (178 mm) C-CAM mid-bass driver 1" (25 mm) C-CAM tweeter
<b>Nominal Impedance</b>	8 Ohms
<b>Amplifier Requirement</b>	35 - 130 W
<b>Continuous Power Handling</b>	65 W
<b>Sensitivity (2.83v @ 1m)</b>	86 dB
<b>Cut Out Size</b>	Ø 212 mm (8 3/8")
<b>Mounting Depth</b>	99 mm (3 7/8")
<b>Dimensions (Ø x D) inc. grille</b>	Ø 242 x 103 mm (Ø 9 1/2 x 4 4/16")
<b>Weight</b>	1.9 kg (4 lb 3 oz)



### C2L-T2X

<b>Drive Units Complement</b>	9" (229 mm) RST II dual-coil mid-bass driver 2 x 1 1/4" (32 mm) C-CAM tweeter
<b>Nominal Impedance</b>	8 Ohms (Stereo) / 4 Ohms (Mono)
<b>Amplifier Requirement</b>	60 - 240 W (Mono) 2 x 60 - 240 W (Stereo)
<b>Continuous Power Handling</b>	240 W (Mono) 2 x 120 W (Stereo)
<b>Sensitivity (2.83v @ 1m)</b>	88 dB
<b>Cut Out Size</b>	Ø 248 mm (9 3/4")
<b>Mounting Depth</b>	99 mm (3 7/8")
<b>Dimensions (Ø x D) inc. grille</b>	Ø 278 x 103 mm (Ø 10 15/16 x 4 4/16")
<b>Weight</b>	2.7 kg (6 lb)



### C2L-CP

<b>Drive Units Complement</b>	9" (229 mm) RST II mid-bass driver 1 1/4" (32 mm) C-CAM tweeter
<b>Nominal Impedance</b>	8 Ohms
<b>Amplifier Requirement</b>	50 - 200 W
<b>Continuous Power Handling</b>	100 W
<b>Sensitivity (2.83v @ 1m)</b>	89 dB
<b>Cut Out Size</b>	Ø 248 mm (9 3/4")
<b>Mounting Depth</b>	177.5 mm (6 9/16")
<b>Dimensions (Ø x D) inc. grille</b>	Ø 278 x 181 mm (Ø 10 15/16 x 7 1/8")
<b>Weight</b>	3.3 kg (7 lb 5 oz)



### C1L

<b>Drive Units Complement</b>	9" (229 mm) C-CAM mid-bass driver 1 1/4" (32 mm) C-CAM tweeter
<b>Nominal Impedance</b>	8 Ohms
<b>Amplifier Requirement</b>	40 - 150 W
<b>Continuous Power Handling</b>	75 W
<b>Sensitivity (2.83v @ 1m)</b>	88 dB
<b>Cut Out Size</b>	Ø 248 mm (9 3/4")
<b>Mounting Depth</b>	99 mm (3 7/8")
<b>Dimensions (Ø x D) inc. grille</b>	Ø 278 x 103 mm (Ø 10 15/16 x 4 4/16")
<b>Weight</b>	2.5 kg (5 lb 8 oz)



### C2S

<b>Drive Units Complement</b>	5" (127 mm) RST II mid-bass driver 1" (25 mm) C-CAM tweeter
<b>Nominal Impedance</b>	8 Ohms
<b>Amplifier Requirement</b>	35 - 130 W
<b>Continuous Power Handling</b>	65 W
<b>Sensitivity (2.83v @ 1m)</b>	84 dB
<b>Cut Out Size</b>	Ø 171 mm (6 3/4")
<b>Mounting Depth</b>	99 mm (3 7/8")
<b>Dimensions (Ø x D) inc. grille</b>	Ø 201 x 103 mm (Ø 7 15/16 x 4 4/16")
<b>Weight</b>	1.5 kg (3 lb 5 oz)



### C3M

<b>Drive Units Complement</b>	7" (178 mm) RDT III bass driver 4" (102 mm) IDC II midrange driver 1" (25 mm) IDC II tweeter
<b>Nominal Impedance</b>	6 Ohm
<b>Amplifier Requirement</b>	45 - 180 W
<b>Continuous Power Handling</b>	120 W
<b>Sensitivity (2.83v @ 1m)</b>	87 dB
<b>Cut Out Size</b>	Ø 212 mm (8 3/8")
<b>Mounting Depth</b>	148 mm (5 13/16")
<b>Dimensions (Ø x D) inc. grille</b>	Ø 242 x 151 mm (Ø 9 1/2 x 5 15/16")
<b>Weight</b>	3.4 kg (7 lb 8 oz)



### C3L

<b>Drive Units Complement</b>	9" (229 mm) RDT III bass driver 4" (102 mm) IDC II midrange driver 1" (25 mm) IDC II tweeter
<b>Nominal Impedance</b>	6 Ohms
<b>Amplifier Requirement</b>	60 - 225 W
<b>Continuous Power Handling</b>	150 W
<b>Sensitivity (2.83v @ 1m)</b>	89 dB
<b>Cut Out Size</b>	Ø 248 mm (9 3/4")
<b>Mounting Depth</b>	157 mm (6 3/16")
<b>Dimensions (Ø x D) inc. grille</b>	Ø 278 x 161 mm (Ø 10 15/16 x 6 5/16")
<b>Weight</b>	5 kg (11 lb)



### C2M

<b>Drive Units Complement</b>	7" (178 mm) RST II mid-bass driver 1" (25 mm) C-CAM tweeter
<b>Nominal Impedance</b>	8 Ohms
<b>Amplifier Requirement</b>	40 - 150 W
<b>Continuous Power Handling</b>	75 W
<b>Sensitivity (2.83v @ 1m)</b>	86 dB
<b>Cut Out Size</b>	Ø 212 mm (8 3/8")
<b>Mounting Depth</b>	99 mm (3 7/8")
<b>Dimensions (Ø x D) inc. grille</b>	Ø 242 x 103 mm (Ø 9 1/2 x 4 4/16")
<b>Weight</b>	2 kg (4 lb 6 oz)



### C2M-T2X

<b>Drive Units Complement</b>	7" (178 mm) RST II dual-coil mid-bass driver 2 x 1" (25 mm) C-CAM tweeter
<b>Nominal Impedance</b>	8 Ohms (Stereo) / 4 Ohms (Mono)
<b>Amplifier Requirement</b>	40-150 W (Mono) 2 x 75 W (Stereo)
<b>Continuous Power Handling</b>	150 W (Mono) 2 x 75 W (Stereo)
<b>Sensitivity (2.83v @ 1m)</b>	86 dB
<b>Cut Out Size</b>	Ø 212 mm (8 3/8")
<b>Mounting Depth</b>	99 mm (3 7/8")
<b>Dimensions (Ø x D) inc. grille</b>	Ø 242 x 103 mm (Ø 9 1/2 x 4 4/16")
<b>Weight</b>	2.1 kg (4 lb 10 oz)



### C3L-CP

<b>Drive Units Complement</b>	9" (229 mm) RDT III bass driver 4" (102 mm) IDC II midrange driver 1" (25 mm) IDC II tweeter
<b>Nominal Impedance</b>	6 Ohm
<b>Amplifier Requirement</b>	45 - 180 W
<b>Continuous Power Handling</b>	120 W
<b>Sensitivity (2.83v @ 1m)</b>	89 dB
<b>Cut Out Size</b>	Ø 248 mm (9 3/4")
<b>Mounting Depth</b>	177.5 mm (6 9/16")
<b>Dimensions (Ø x D) inc. grille</b>	Ø 278 x 181 mm (Ø 10 15/16 x 7 1/8")
<b>Weight</b>	5.7 kg (12 lb 10 oz)



### C3L-A

<b>Drive Units Complement</b>	9" (229 mm) RDT III bass driver 4" (102 mm) IDC II midrange driver 1" (25 mm) IDC II tweeter
<b>Nominal Impedance</b>	6 Ohms
<b>Amplifier Requirement</b>	60 - 225 W
<b>Continuous Power Handling</b>	150 W
<b>Sensitivity (2.83v @ 1m)</b>	89 dB
<b>Cut Out Size</b>	Ø 248 mm (9 3/4")
<b>Mounting Depth</b>	157 mm (6 3/16")
<b>Dimensions (Ø x D) inc. grille</b>	Ø 278 x 161 mm (Ø 10 15/16 x 6 5/16")
<b>Weight</b>	5.6 kg (12 lb 5 oz)



### C2M-CP

<b>Drive Units Complement</b>	7" (178 mm) RST II mid-bass driver 1" (25 mm) C-CAM tweeter
<b>Nominal Impedance</b>	8 Ohms
<b>Amplifier Requirement</b>	35 - 130 W
<b>Continuous Power Handling</b>	65 W
<b>Sensitivity (2.83v @ 1m)</b>	87 dB
<b>Cut Out Size</b>	Ø 212 mm (8 3/8")
<b>Mounting Depth</b>	177.5 mm (6 9/16")
<b>Dimensions (Ø x D) inc. grille</b>	Ø 242 x 181.5 mm (Ø 9 1/2 x 7 1/8")
<b>Weight</b>	2.6 kg (5 lb 11 oz)



### C2L

<b>Drive Units Complement</b>	9" (229 mm) RST II mid-bass driver 1 1/4" (32 mm) C-CAM tweeter
<b>Nominal Impedance</b>	8 Ohms
<b>Amplifier Requirement</b>	60 - 240 W
<b>Continuous Power Handling</b>	120 W
<b>Sensitivity (2.83v @ 1m)</b>	88 dB
<b>Cut Out Size</b>	Ø 248 mm (9 3/4")
<b>Mounting Depth</b>	99 mm (3 7/8")
<b>Dimensions (Ø x D) inc. grille</b>	Ø 278 x 103 mm (Ø 10 15/16 x 4 4/16")
<b>Weight</b>	2.5 kg (5 lb 8 oz)



### CSS230 (M)

<b>Drive Units Complement</b>	3 x 3" (76 mm) C-CAM mid-bass drivers 3/4" (19 mm) C-CAM tweeter
<b>Nominal Impedance</b>	8 Ohms
<b>Amplifier Requirement</b>	10 - 60 W
<b>Continuous Power Handling</b>	40 W
<b>Sensitivity (1w @ 1m)</b>	86 dB
<b>Cut Out Size</b>	Ø 211 mm (8 5/16")
<b>Mounting Depth</b>	50 mm (1 15/16")
<b>Dimensions (Ø x D) inc. grille</b>	Ø 250 x 54 mm (Ø 9 13/16 x 2 1/8")
<b>Weight</b>	2.88 kg (6 lb 5 oz)





Pictured: C1S In-Ceiling Speakers





# In-Wall

The in-wall loudspeaker is a versatile, high-performance tool that can add localised quality to any custom installation. The Creator Series in-wall models allow you to create areas of high-performance sound, often to create a dedicated home cinema space, that rival that of stand-alone loudspeakers while remaining virtually invisible.

# Innovative solutions



### Dual Drivers

Tier 2 and 3 in-wall models have been updated to feature a dual-bass driver arrangement. Positioned either side of the HF/MF array, this configuration improves linearity between drivers and ensures a much larger, purer and cleaner sound is delivered into the listening area, and with greater bass extension.

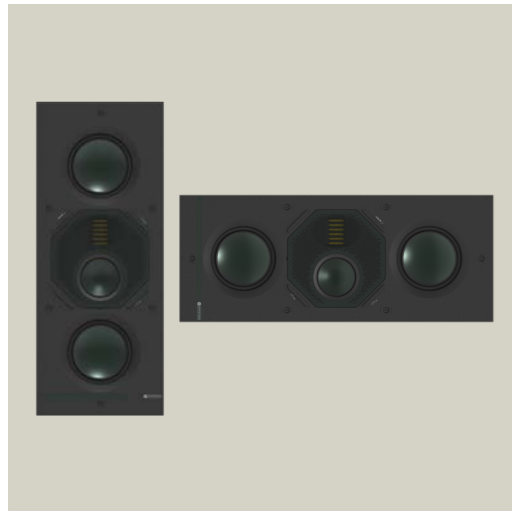

### Mid-Pod Rotation

Tier 2 and Tier 3 in-wall models feature a rotating mid-pod driver array. This mid-pod array can be rotated to allow the speakers to be positioned within a vertical or horizontal plain - to suit the application - at the installation stage. This highly flexible solution ensures that the phase of the transducer is correct in each orientation.

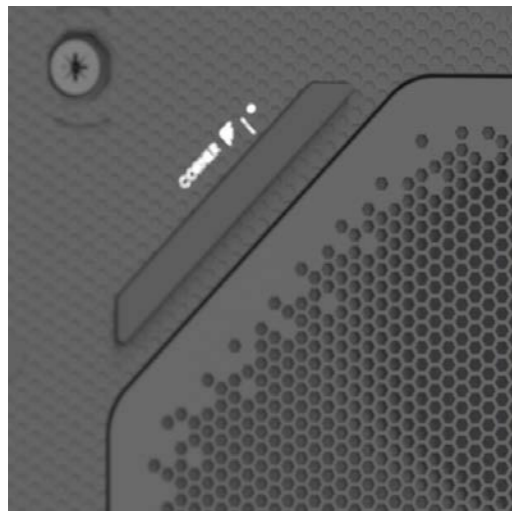

### Boundary EQ

All the Creator Series in-wall models perform exceptionally well in a variety of locations, including when close to secondary walls. However, as you move up through the tiers, the models feature enhanced technologies such as boundary correction and high- and mid-frequency cut/boost that allows them to be placed in trickier locations such as corners. Because sound performance shouldn't be compromised by placement.

# Sizing

The Creator Series features small, medium and large in-wall models. Each size is defined by a cut-out dimension that allows installers to select the perfect array of speakers for your space.

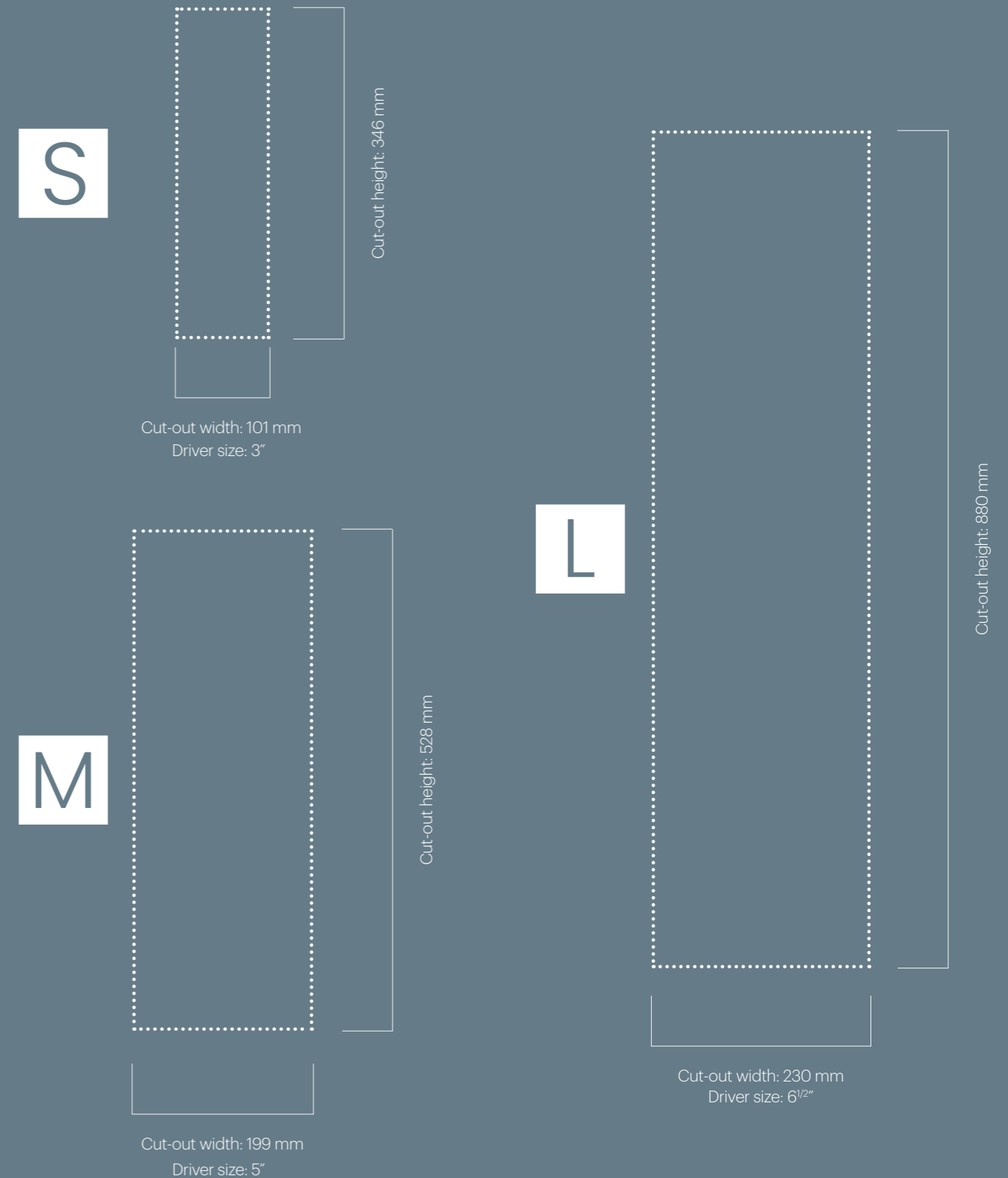



### WSS130 (S)

<b>Drive Units Complement</b>	3 x 3" (76 mm) MMP II mid-bass drivers 1" (25 mm) C-CAM tweeter
<b>Nominal Impedance</b>	8 Ohms
<b>Amplifier Requirement</b>	10 - 100 W
<b>Continuous Power Handling</b>	60 W (100 W with crossover set to 100 Hz @ 12 dB/Octave)
<b>Sensitivity (1w @ 1m)</b>	87 dB
<b>Cut Out Size</b>	346 x 101 mm (13 5/8 x 3 3/32")
<b>Mounting Depth</b>	50 mm (1 3/16")
<b>Dimensions (H x W x D) inc. grille</b>	385 x 140.5 x 54.25 mm (15 x 5 1/2 x 2 1/8")
<b>Weight</b>	1.4 kg (3 lb 2 oz)



### WSS230 (S)

<b>Drive Units Complement</b>	3 x 3" (76 mm) C-CAM mid-bass drivers 1" (25 mm) C-CAM tweeter
<b>Nominal Impedance</b>	8 Ohms
<b>Amplifier Requirement</b>	10 - 100 W
<b>Continuous Power Handling</b>	60 W (100 W with crossover set to 100 Hz @ 12 dB/Octave)
<b>Sensitivity (1w @ 1m)</b>	87 dB
<b>Cut Out Size</b>	346 x 101 mm (13 5/8 x 3 3/32")
<b>Mounting Depth</b>	50 mm (1 3/16")
<b>Dimensions (H x W x D) inc. grille</b>	385 x 140.5 x 54.25 mm (15 x 5 1/2 x 2 1/8")
<b>Weight</b>	1.4 kg (3 lb 2 oz)



### CP-IW260X (L)

<b>Drive Units Complement</b>	2 x 6 1/2" (165 mm) C-CAM bass drivers 2 x 4" (102 mm) C-CAM midrange drivers 1" (25 mm) C-CAM tweeter
<b>Nominal Impedance</b>	6 Ohms
<b>Amplifier Requirement</b>	60 - 150 W
<b>Continuous Power Handling</b>	150 W
<b>Sensitivity (2.83v @ 1m)</b>	89 dB
<b>Cut Out Size</b>	880 x 230 mm (34 5/8 x 9 1/16")
<b>Mounting Depth</b>	96 mm (3 3/8")
<b>Dimensions (H x W x D) inc. grille</b>	907 x 257 x 102 mm (35 3/4 x 10 1/8 x 4")
<b>Weight</b>	12 kg (26 lb 6 oz)



### CP-IW460X (L)

<b>Drive Units Complement</b>	2 x 6 1/2" (165 mm) RST C-CAM bass drivers 2 x 4" (102 mm) RST C-CAM mid-range drivers C-CAM H.F ribbon transducer
<b>Nominal Impedance</b>	6 Ohms
<b>Amplifier Requirement</b>	60 - 150 W
<b>Continuous Power Handling</b>	150 W
<b>Sensitivity (2.83v @ 1m)</b>	89 dB
<b>Cut Out Size</b>	880 x 230 mm (34 5/8 x 9 1/16")
<b>Mounting Depth</b>	96 mm (3 3/8")
<b>Dimensions (H x W x D) inc. grille</b>	907 x 257 x 102 mm (35 3/4 x 10 1/8 x 4")
<b>Weight</b>	13 kg (28 lb 6 oz)



### WSS430 (S)

<b>Drive Units Complement</b>	3 x 3" (76 mm) C-CAM mid-bass drivers MPD High frequency transducer
<b>Nominal Impedance</b>	8 Ohms
<b>Amplifier Requirement</b>	10 - 120 W
<b>Continuous Power Handling</b>	75 W Full range (120 W with crossover set to 100 Hz @ 12 dB/Octave)
<b>Sensitivity (1w @ 1m)</b>	87 dB
<b>Cut Out Size</b>	346 x 101 mm (13 5/8 x 3 3/32")
<b>Mounting Depth</b>	50 mm (1 3/16")
<b>Dimensions (H x W x D) inc. grille</b>	385 x 140.5 x 54.25 mm (15 x 5 1/2 x 2 1/8")
<b>Weight</b>	1.1 kg (2 lb 6 oz)



### W1M-E

<b>Drive Units Complement</b>	5" (127 mm) C-CAM mid-bass driver 1" (25 mm) C-CAM tweeter
<b>Nominal Impedance</b>	8 Ohms
<b>Amplifier Requirement</b>	25 - 100 W
<b>Continuous Power Handling</b>	50 W
<b>Sensitivity (2.83v @ 1m)</b>	85 dB
<b>Cut Out Size</b>	527 x 198 mm (20 3/4 x 7 13/16")
<b>Mounting Depth</b>	85 mm (3 3/8")
<b>Dimensions (H x W x D) inc. grille</b>	560 x 231 x 90 mm (22 1/8 x 9 1/8 x 3 5/16")
<b>Weight</b>	2.6 kg (5 lb 11 oz)



### W1M

<b>Drive Units Complement</b>	2 x 5" (127 mm) C-CAM mid-bass driver 1" (25 mm) C-CAM tweeter
<b>Nominal Impedance</b>	6 Ohms
<b>Amplifier Requirement</b>	30 - 110 W
<b>Continuous Power Handling</b>	75 W
<b>Sensitivity (2.83v @ 1m)</b>	85 dB
<b>Cut Out Size</b>	527 x 198 mm (20 3/4 x 7 13/16")
<b>Mounting Depth</b>	85 mm (3 3/8")
<b>Dimensions (H x W x D) inc. grille</b>	560 x 231 x 90 mm (22 1/8 x 9 1/8 x 3 5/16")
<b>Weight</b>	3.4 kg (7 lb 8 oz)



### W2M

<b>Drive Units Complement</b>	2 x 5" (127 mm) RST II bass driver 3" (76 mm) RST II midrange driver 1" (25 mm) C-CAM tweeter
<b>Nominal Impedance</b>	6 Ohms
<b>Amplifier Requirement</b>	45-180 W
<b>Continuous Power Handling</b>	120 W
<b>Sensitivity (2.83v @ 1m)</b>	87 dB
<b>Cut Out Size</b>	527 x 198 mm (20 3/4 x 7 13/16")
<b>Mounting Depth</b>	85 mm (3 3/8")
<b>Dimensions (H x W x D) inc. grille</b>	560 x 231 x 90 mm (22 1/8 x 9 1/8 x 3 5/16")
<b>Weight</b>	3.9 kg (8 lb 9 oz)



### W2M-CP

<b>Drive Units Complement</b>	2 x 5" (127 mm) RST II bass driver 3" (76 mm) RST II midrange driver 1" (25 mm) C-CAM tweeter
<b>Nominal Impedance</b>	6 Ohms
<b>Amplifier Requirement</b>	40 - 150 W
<b>Continuous Power Handling</b>	100 W
<b>Sensitivity (2.83v @ 1m)</b>	87 dB
<b>Cut Out Size</b>	527 x 198 mm (20 3/4 x 7 13/16")
<b>Mounting Depth</b>	97 mm (3 3/16")
<b>Dimensions (H x W x D) inc. grille</b>	560 x 231 x 102 mm (22 1/8 x 9 1/8 x 4 1/16")
<b>Weight</b>	4.4 kg (9 lb 11 oz)



### W3M

<b>Drive Units Complement</b>	2 x 5" (127 mm) RDT III bass driver 3" (76 mm) C-CAM midrange driver MPD tweeter
<b>Nominal Impedance</b>	6 Ohms
<b>Amplifier Requirement</b>	60 - 225 W
<b>Continuous Power Handling</b>	150 W
<b>Sensitivity (2.83v @ 1m)</b>	88 dB
<b>Cut Out Size</b>	527 x 198 mm (20 3/4 x 7 13/16")
<b>Mounting Depth</b>	85 mm (3 3/8")
<b>Dimensions (H x W x D) inc. grille</b>	560 x 231 x 90 mm (22 1/8 x 9 1/8 x 3 5/16")
<b>Weight</b>	4.7 kg (10 lb 6 oz)







# Cinergy

## True cinema sound at home

Offering all the thrills of the very best cinema, but focusing the experience around you and those closest to you. With Cinergy you create a completely bespoke cinematic experience; immersive, precise, natural, and private.

Explore Cinergy  
at [monitoraudio.com](http://monitoraudio.com)





# Technology



## THX® Certified Ultra

THX is the gold standard for audio and visual fidelity: a globally recognised mark assuring you and your customer that Cinergy will deliver the ultimate home cinema experience\*. It's not simply a set of measurements done on a computer or in a lab. THX certification is done using the dynamics of real-world listening, so you can have the utmost confidence in the equipment you install.

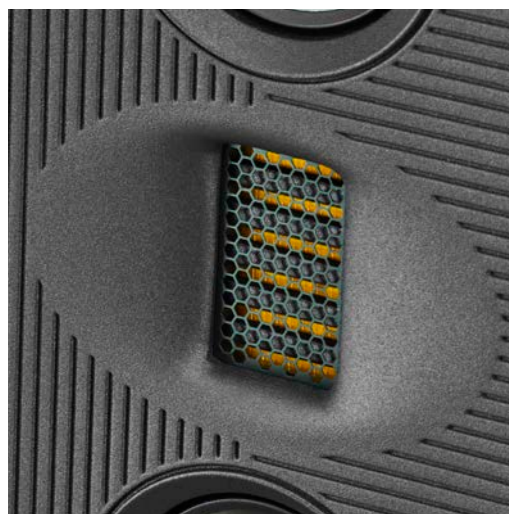

## MPD III high-frequency transducer

Cinergy's high-frequency transducer is designed to produce accurate, lifelike sound without any distortion that will take you out of the moment. It's all made possible by our Micro Pleated Diaphragm technology. Think of it as a super-fast accordion, which squeezes the pleats to develop the smoothest possible output.



## RDT II bass drivers

Loud, dynamic bass. High power handling. The lowest distortion of any driver we've ever made. Just some advantages of Rigid Diaphragm Technology. It's a 'sandwich' of ultra-thin, low-mass skins bonded to a honeycomb Nomex® core, making our bass drivers both exceptionally strong and lightweight.



## Isolating Brackets

Cinergy comes with a range of practical isolation accessories. These were developed in-house by our specialist audio engineers, to ensure they're optimised for use with Cinergy. From 3-layer silicone feet isolators to L-shaped bracket isolators, small touches ensure powerful sound is delivered cleanly and crisply, with vibrations reduced by up to 18dB.



## Rotates to suit you

The mid-tweeter array on the Cinergy 100, 200 and 300 easily rotate, depending on whether you'd prefer it to be a vertical or horizontal install. So there's no need to compromise on your design vision when you're searching for the perfect sound.

## Cinergy 100

**Drive Units Complement** 8" (203mm) RDT II Bass Driver  
2 1/2" (64 mm) C-CAM Mid-Bass Driver  
MPD III Transducer

**Nominal Impedance** 4 Ohms

**Amplifier Requirement** 100 - 800 W

**Power Handling** Continuous 200 W, Peak 800 W

**Sensitivity** (2.83v @ 1m) 89 dB

**Dimensions (H x W x D) inc. grille** 460 x 350 x 174.1 mm  
(18 1/8" x 13 3/4" x 6 7/8")

**Weight** 18.4 kg (40 lb 8 oz)



## Cinergy 200

**Drive Units Complement** 8" (203mm) RDT II Bass Driver  
2 1/2" (64 mm) C-CAM Mid-Bass Driver  
MPD III Transducer

**Nominal Impedance** 4 Ohms

**Amplifier Requirement** 200 - 1400 W

**Power Handling** Continuous 350 W, Peak\* 1400 W

**Sensitivity** (2.83v @ 1m) 90 dB

**Dimensions (H x W x D) inc. grille** 904 x 300 x 173.6 mm  
(35 5/8" x 11 7/8" x 6 7/8")

**Weight** 30 kg (66 lb)



## Cinergy 300

**Drive Units Complement** 8" (203mm) RDT II Bass Driver  
2 x 2 1/2" (64 mm) C-CAM  
mid-bass driver  
MPD III Transducer

**Nominal Impedance** 4 Ohms

**Amplifier Requirement** 200 - 1400 W

**Power Handling** Continuous 350 W, Peak\* 1400 W

**Sensitivity** (2.83v @ 1m) 90 dB

**Dimensions (H x W x D) inc. grille** 1080 x 300 x 253.6 mm  
(42 1/2" x 11 7/8" x 10")

**Weight** 40.4 kg (88 lb 14 oz)



## Cinergy Sub15

**Drive Units Complement** 15" (381 mm) Ultra high Excursion  
C-CAM Driver

**Nominal Impedance** 4 Ohms

**Amplifier Requirement** Must be used with IA750-2 /  
IA750-4 running C Sub Profile

**Power Handling** Continuous 600 W,  
Peak 1500 W (Band limited)

**Sensitivity** (2.83v @ 1m) 86 dB @ 100 Hz

**Dimensions (H x W x D)** 540 x 540 x 280 mm  
(21 1/4" x 21 1/4" x 11")

**Weight** 38.5 kg (84 lb 12 oz)







# Anthra Subwoofer Series

Deep, Controlled Bass. Simply.

It takes confidence to dare to be simple. Anthra subwoofers embrace this methodology. This all-new standalone three-model subwoofer series partners innovative acoustic know-how with an intuitive user-experience. Which isn't as simple as it sounds.

Explore Anthra  
at [monitoraudio.com](https://www.monitoraudio.com)



# Technology



## RST II Bass Driver

All Anthra subwoofer drivers feature Rigid Surface Technology II (RST II) and ceramic-coated aluminium magnesium cones (C-CAM). RST II significantly increases cone rigidity, allowing the radiating surface to resist mechanical bending forces, especially under the significant forces that Anthra amplifiers are capable of supplying, which can twist the shape of conventional driver cones to produce distorted sound and ultimately damage the driver.



## Class-D Amplifiers

Behind the RST II C-CAM high-excursion driver lies a formidable amplifier capable of jaw-dropping power. With Class-D 425, 900 and a massive 1,400 Watts RMS at continuous levels with peak demand reaching 500, 1,700 and a massive 2,500 Watts, each amplifier ensures that the drivers are working to their optimum performance levels, no matter what the volume.

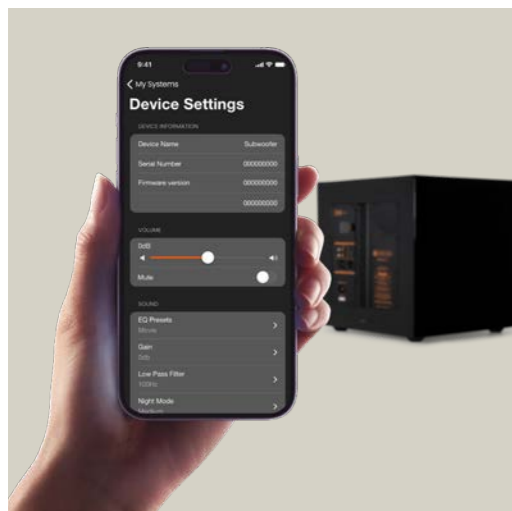

## MaestroUnite Setup App

Via the in-house-designed MaestroUnite setup app, users can optimally configure any Anthra subwoofer to their individual tastes and system requirements.

The app allows complete bespoke setup using basic or advanced features. Thanks to options including EQ pre-sets (configurable by either Monitor Audio or the user), Gain, Low Pass Filter, Auto-On, LED Control, Phase and LPF Slope and many more, a user has complete control over the setup of their Anthra subwoofer.



## Anthra W10

<b>Drive Units Complement</b>	10" (254 mm) High Linear-Excursion Triple Suspension Driver
<b>Amplifier Classification</b>	High-Efficiency Class-D
<b>Amplifier Output Power, 240Vac</b>	Instantaneous: 500W Continuous short-term: 425W
<b>Amplifier Output Power, 120Vac</b>	Instantaneous: 450W Continuous short-term: 390W
<b>Power consumption</b>	120W
<b>Dimensions (H x W x D) ex. feet</b>	321 x 321 x 321 mm (12 5/8" x 12 5/8" x 12 5/8")
<b>Weight</b>	20 kg (44 lb 1 oz)



## Anthra W12

<b>Drive Units Complement</b>	12" (305 mm) High Linear-Excursion Triple Suspension Driver
<b>Amplifier Classification</b>	High-Efficiency Class-D
<b>Amplifier Output Power, 240Vac</b>	Instantaneous: 1700W Continuous short-term: 900W
<b>Amplifier Output Power, 120Vac</b>	Instantaneous: 1325W Continuous short-term: 700W
<b>Power consumption</b>	200W
<b>Dimensions (H x W x D) ex. feet</b>	374 x 374 x 374 mm (14 3/4" x 14 3/4" x 14 3/4")
<b>Weight</b>	28.6 kg (63 lb 1 oz)



## Anthra W15

<b>Drive Units Complement</b>	15" (381 mm) High Linear-Excursion Triple Suspension Driver
<b>Amplifier Classification</b>	High-Efficiency Class-D
<b>Amplifier Output Power, 240Vac</b>	Instantaneous: 2500W Continuous short-term: 1400W
<b>Amplifier Output Power, 120Vac</b>	Instantaneous: 2500W Continuous short-term: 1400W
<b>Power consumption</b>	550W
<b>Dimensions (H x W x D) ex. feet</b>	439 x 439 x 439 mm (17 5/8" x 17 5/8" x 17 5/8")
<b>Weight</b>	35.4 kg (78 lb 1 oz)







# Platinum

## The last word in installed sound

The Platinum range of architectural loudspeakers contains Monitor Audio's flagship custom installation models. Designed for use in high-end audio and movie systems, where accurate, clear and lifelike sound is required, they deliver maximum scale and sonic impact, with the minimum of room intrusion.

Explore Platinum  
at [monitoraudio.com](http://monitoraudio.com)





# Platinum In-Wall 3G

The Platinum In-Wall 3G can be installed either vertically or horizontally, which means it can be used on any channel within a surround sound set up. It's ideal for use in LCR applications, and for delivering seamless tonal accuracy within a theatre system.



# Technology



### MPD III High-Frequency Transducer

Pinpoint accuracy for lifelike sound. The improvements made on MPD III help to reduce distortion and flatten the frequency response leading to a clear and consistent sound across all your music.



### RDT III Drivers

The Rigid Diaphragm Technology III (RDT III) cone has three new optimisations over its predecessor. New rear layer featuring two uniform layers of carbon fibre skin to reduce cone breakup. Optimised cone edge treatment to extend passband of drivers Optimised rubber surround to reduce cone breakup Combined the above improvements significantly increase the useable bandwidth enabling improvements to the crossover and final response of the speaker.



### Tri-Grip Dog Legs

Our patented Tri-Grip mounting clamps have three clamping points per dogleg. Providing a better seal between the speaker and the wall.

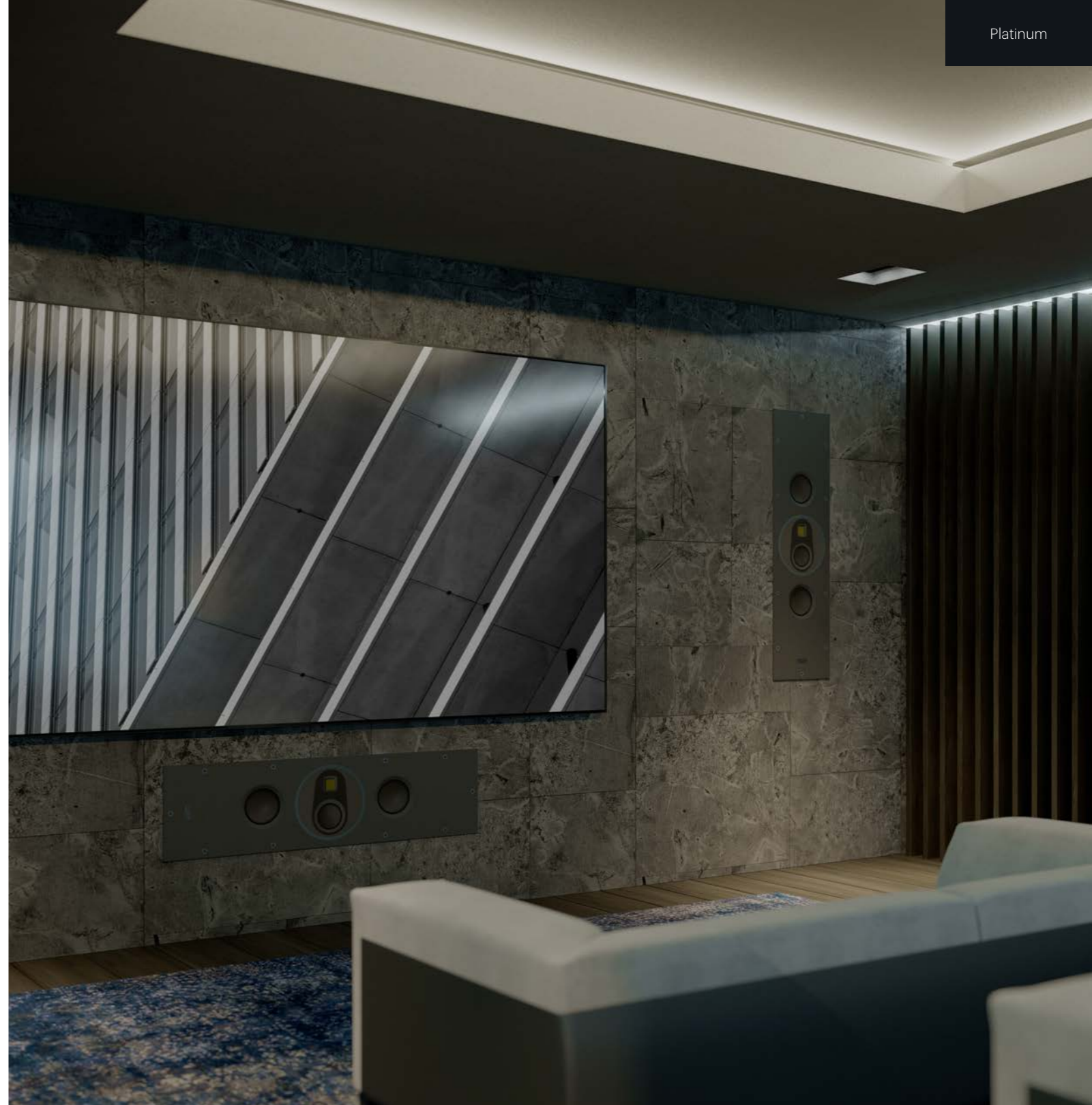

### Platinum In-Wall 3G

<b>Drive Units Complement</b>	2 x 6" (152 mm) RDT III bass drivers 4" (102 mm) RDT II mid-range driver MPD III tweeter
<b>Nominal Impedance</b>	4 Ohms
<b>Amplifier Requirement</b>	150 - 600 W
<b>Continuous Power Handling</b>	300 W
<b>Sensitivity (2.83v @ 1m)</b>	88 dB
<b>Cut Out Size</b>	1175 x 300 mm (46 1/4 x 11 13/16")
<b>Mounting Depth</b>	97.5 mm (3 14/16")
<b>Dimensions (H x W x D) inc. grille</b>	1207 x 332 x 105.5 mm (7 11/16 x 13 1/16 x 4 1/16")
<b>Weight</b>	27.7 kg (61 lb)





# PLIC II

Designed for installation in both new build and retrofit installations, this Platinum series in-ceiling speaker is the 'go-to' product for home technology professionals, architects, interior designers and end users.

## Technology

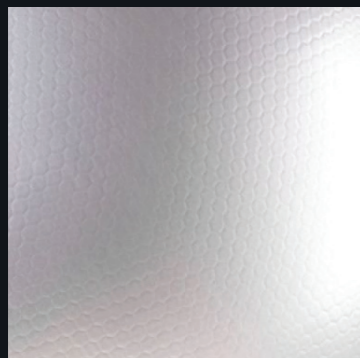

### RDT II mid-bass driver

Rigid Diaphragm Technology II (RDT II) is a composite 'sandwich' structure made from ultra-thin low-mass skins, bonded to a honeycomb Nomex® core material. It is very light and very strong, meaning that it can respond with great speed without bending - just like a perfect piston.



### MPD Transducer

The proprietary low-mass pleated diaphragm has a surface area eight times larger than that of a traditional dome tweeter. The MPD transducer works like a super-fast accordion by rapidly squeezing the pleats to produce a smooth, wide, naturally fast response.



### Tri-Grip Dog Legs

Our patented Tri-Grip mounting clamps have three clamping points per dogleg. Providing a better seal between the speaker and the ceiling.



### PLIC II

**Drive Units Complement** 8" (203 mm) RDT II bass driver  
2 x 2" (51 mm) C-CAM mid-range drivers  
MPD HF transducer

**Nominal Impedance** 4 Ohms

**Amplifier Requirement** 50 - 150 W

**Continuous Power Handling** 150 W

**Sensitivity (1W@1M)** 90 dB

**Cut Out Size** Ø 273 mm (Ø 10 3/4")

**Mounting Depth** 185 mm (7 5/16")

**Dimensions (Ø x D) inc. grille** Ø 309 x 191.5 mm (Ø 12 3/16 x 7 7/16")

**Weight** 5.2 kg (11 lb 8 oz)



### PLIC-BOX II







# Weather Resistant

Great sound, whatever the weather

Our comprehensive range of Weather Resistant loudspeakers allows you to experience pristine sound in a variety of high-moisture environments including as saunas and bathrooms, as well as extreme locations such as in your garden or even onboard a boat.

Explore Weather  
Resistant speakers  
at [monitoraudio.com](https://www.monitoraudio.com)







# Vecta

Versatile, flexible and discreet, our range of Vecta loudspeakers are capable of delivering high-quality sound both inside and out. Wall mounted either horizontally or vertically, Vecta can be discreetly installed under eaves, straight onto the wall, or configured as a group for 360-degree sound with the LV version. A curved baffle minimises ceiling and wall reflections to deliver a controlled sound field and wide dispersion.



# Flexible mounting options

There is a choice of three intelligently designed brackets. V-MOUNT can be used to mount speakers flat on a wall with the option of using the supplied Wedge. For installation under eaves or in vertical corners, there is the V-CORNER bracket. Two speakers can be mounted back to back using a pair of V-CORNERS. The V-CLUSTER bracket can be suspended from above and supports four V240-LV speakers giving 360° sound.

All three brackets automatic connection system means that the install is extremely sleek, with no wires visible.

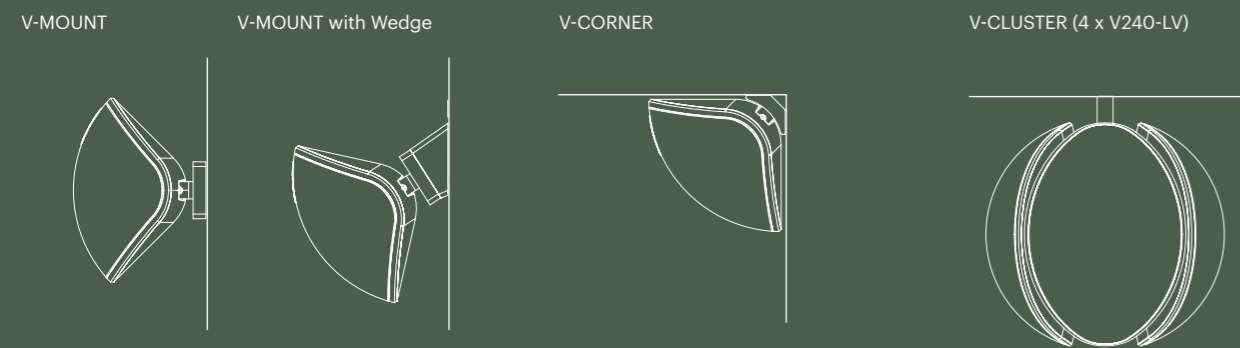

**V240**

<b>Drive Units Complement</b>	2 x 4" (102 mm) C-CAM mid-bass drivers 1" (25 mm) C-CAM tweeter
<b>Nominal Impedance</b>	4 Ohms
<b>Amplifier Requirement</b>	25 – 100 W
<b>Continuous Power Handling</b>	100 W
<b>Sensitivity (2.83v @ 1m)</b>	88 dB
<b>IP Rating</b>	IP55 -25° to 65° C
<b>Dimensions (H x W x D) inc. grille</b>	336 x 243 x 150 mm (13 <sup>3/4</sup> x 9 <sup>5/16</sup> x 5 <sup>7/8</sup> "
<b>Weight</b>	2.55 kg (5 lb 10 oz)
<b>Finishes</b>	White / Black



**V240-LV**

<b>Drive Units Complement</b>	2 x 4" (102 mm) C-CAM mid-bass drivers 1" (25 mm) C-CAM tweeter
<b>Nominal Impedance</b>	70/100 Volt line level
<b>Amplifier Requirement</b>	25 – 100 W
<b>Continuous Power Handling</b>	100 W
<b>Sensitivity (2.83v @ 1m)</b>	88 dB
<b>IP Rating</b>	IP55 -25° to 65° C
<b>Dimensions (H x W x D) inc. grille</b>	336 x 243 x 150 mm (13 <sup>3/4</sup> x 9 <sup>5/16</sup> x 5 <sup>7/8</sup> "
<b>Weight</b>	3.56 kg (7 lb 14 oz)
<b>Finishes</b>	White / Black

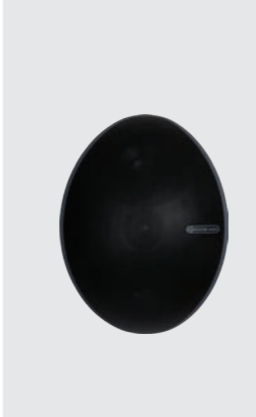

V-MOUNT



V-CORNER



V-CLUSTER

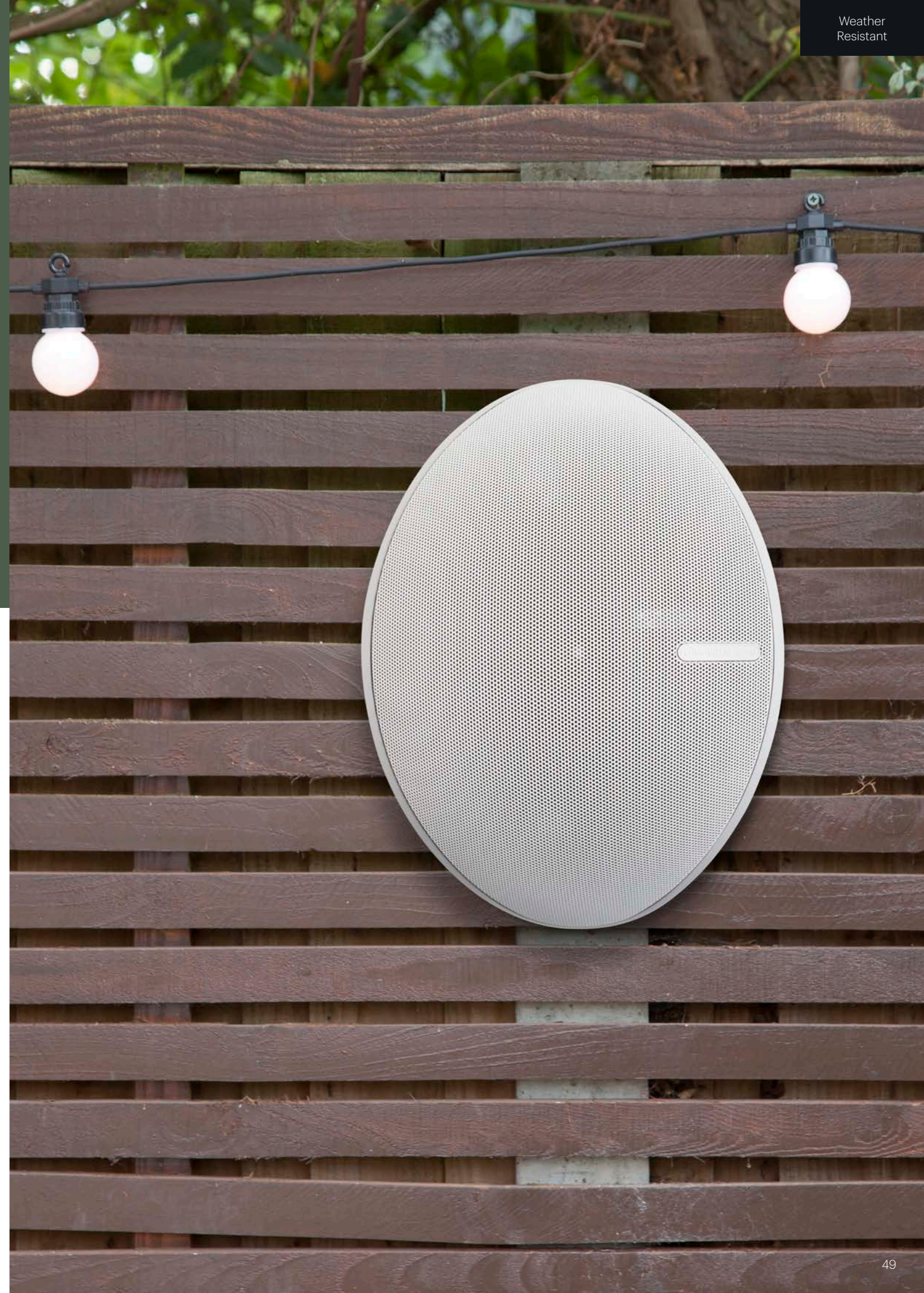



# Climate Garden

The Climate Garden series comprises a range of super discreet all-weather satellite speakers and a subwoofer. Designed for ground-level installation among shrubs and trees, the range delivers a blend of unobtrusive aesthetics and natural full-range audio in gardens of any size. 70/100 V line arrays of up to twelve satellites per subwoofer means a Climate Garden system is expandable with additional satellite and subwoofer sets according to the space you are looking to fill with sensational sound.



# Sound of the great outdoors

The system's super-discreet all-weather satellite/subwoofer design has been expertly created by our designers for ground level installation amongst shrubs and trees. The speaker system delivers a luxurious blend of unobtrusive aesthetics and natural full-range audio in gardens of any size.

Comprising the CLG140 and CLG160 satellite speakers and CLG-W10 and CLG-W12 subwoofers 'daisy-chained' together in 70/100 V line arrays of up to sixteen satellites and two subwoofers, the set-up is expandable by adding additional satellite, subwoofer and amplifier sets according to garden size.

Operating temperature range: -20° to 70° C / -4° to 158° F.

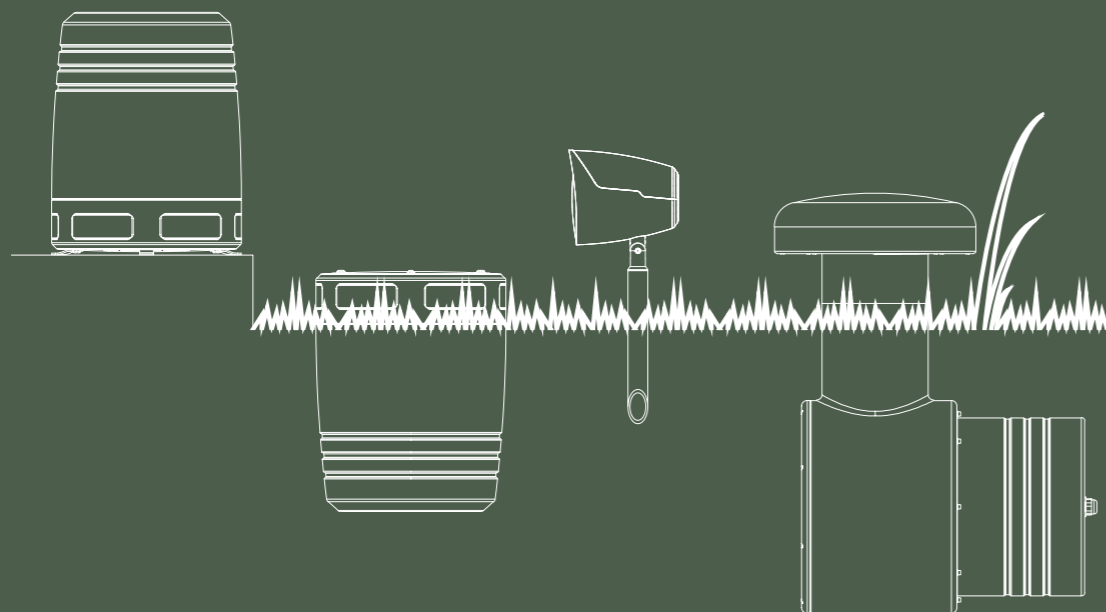

## CLG140

<b>Drive Units Complement</b>	4" (102 mm) MMP II mid-bass driver 1" (25 mm) C-CAM tweeter
<b>Nominal Impedance</b>	70/100 Volt line level
<b>Amplifier Requirement</b>	10 – 40 W
<b>Continuous Power Handling</b>	40 W
<b>Sensitivity (1w @ 1m)</b>	88 dB
<b>IP Rating</b>	IP55
<b>Dimensions (H x W) ex. mount</b>	130 x 175 mm (5 <sup>1/8</sup> x 6 <sup>7/8</sup> )
<b>Weight</b>	2 kg (4 lb 10 oz)
<b>Finishes</b>	Brown



## CLG160

<b>Drive Units Complement</b>	6" (152 mm) MMP II mid-bass driver 1" (25 mm) C-CAM tweeter
<b>Nominal Impedance</b>	70/100 Volt line level
<b>Amplifier Requirement</b>	10 – 60 W
<b>Continuous Power Handling</b>	60 W
<b>Sensitivity (1w @ 1m)</b>	89 dB
<b>IP Rating</b>	IP55
<b>Dimensions (H x W) ex. mount</b>	190 x 220 mm (7 <sup>1/2</sup> x 8 <sup>5/8</sup> )
<b>Weight</b>	2.76 kg (6 lb 2 oz)
<b>Finishes</b>	Brown



## CLG-SPIKE R



## CLG-MOUNT



## CLG-W10

<b>Drive Units Complement</b>	10" (254 mm) 'ICD' subwoofer C-CAM cone
<b>Nominal Impedance</b>	4 Ohms or 70/100 Volt line level
<b>Amplifier Requirement</b>	100 – 150 W
<b>Continuous Power Handling</b>	150 W
<b>Sensitivity (1w @ 1m)</b>	85 dB
<b>IP Rating</b>	IP54
<b>Dimensions (H x W x D)</b>	340 x 340 x 434.5 mm (13 <sup>3/8</sup> x 13 <sup>3/8</sup> x 17 <sup>1/8</sup> )
<b>Weight</b>	11.8 kg (26 lb)
<b>Finishes</b>	Brown



## CLG-W12

<b>Drive Units Complement</b>	12" (305 mm) C-CAM bass driver
<b>Nominal Impedance</b>	4 Ohms or 70/100 Volt line level
<b>Amplifier Requirement</b>	100 – 250 W
<b>Continuous Power Handling</b>	250 W
<b>Sensitivity (1w @ 1m)</b>	87 dB
<b>IP Rating</b>	IP54
<b>Dimensions (H x W x D)</b>	750 x 380 x 505.5 mm (19 <sup>1/2</sup> x 14 <sup>5/8</sup> x 19 <sup>1/8</sup> )
<b>Weight</b>	19.5 kg (42 lb 14 oz)
<b>Finishes</b>	Brown





# All-Weather

The All Weather in-ceiling series features a weatherproof construction for installation in extreme environments such as bathrooms, beach houses, saunas or even boats. It offers long-term high-performance reliability thanks to its heightened levels of water, dust, corrosion, UV and temperature protection. These speakers feature super-discreet stainless-steel grilles and are certified against salt spray, UV stability, water, vibration and anti-corrosion.

Operating temperature range: -34° to 79° C / -29° to 174° F.

## AWC265

<b>Drive Units Complement</b>	6 <sup>1/2</sup> " (165 mm) C-CAM mid-bass driver 1" (25 mm) C-CAM tweeter
<b>Nominal Impedance</b>	8 Ohms
<b>Amplifier Requirement</b>	20 - 60 W
<b>Continuous Power Handling</b>	60 W
<b>Sensitivity (1w @ 1m)</b>	88 dB
<b>Cut Out Size</b>	Ø 211 mm (8 3/8")
<b>Mounting Depth</b>	88.5 mm (3 1/2")
<b>IP Rating</b>	Front: IP55 Rear: IP4X
<b>Dimensions (Ø x D) inc. grille</b>	Ø 251 x 93.5 mm (Ø 9 9/16" x 3 7/8")
<b>Weight</b>	2.04 kg (4 lb 8 oz)



## AWC265-T2

<b>Drive Units Complement</b>	6 <sup>1/2</sup> " (165 mm) C-CAM mid-bass driver 2 x 1" (25 mm) C-CAM tweeter
<b>Nominal Impedance</b>	8 + 8 Ohms
<b>Amplifier Requirement</b>	20 - 60 W
<b>Continuous Power Handling</b>	60 W
<b>Sensitivity (1w @ 1m)</b>	88 dB
<b>Cut Out Size</b>	Ø 211 mm (8 3/8")
<b>Mounting Depth</b>	88.5 mm (3 1/2")
<b>IP Rating</b>	Front: IP55 Rear: IP4X
<b>Dimensions (Ø x D) inc. grille</b>	Ø 251 x 93.5 mm (Ø 9 9/16" x 3 7/8")
<b>Weight</b>	2.04 kg (4 lb 8 oz)



## AWC280

<b>Drive Units Complement</b>	8" (203 mm) C-CAM mid-bass driver 1" (25 mm) C-CAM tweeter
<b>Nominal Impedance</b>	8 Ohms
<b>Amplifier Requirement</b>	20 - 100 W
<b>Continuous Power Handling</b>	100 W
<b>Sensitivity (1w @ 1m)</b>	89 dB
<b>Cut Out Size</b>	Ø 247 mm (9 3/4")
<b>Mounting Depth</b>	97.6 mm (3 7/8")
<b>IP Rating</b>	Front: IP55 Rear: IP4X
<b>Dimensions (Ø x D) inc. grille</b>	Ø 285 x 102.5 mm (Ø 11 1/4" x 4 1/8")
<b>Weight</b>	2.8 kg (6 lb 2 oz)



## AWC280-T2

<b>Drive Units Complement</b>	8" (203 mm) C-CAM mid-bass driver 2 x 1" (25 mm) C-CAM tweeter
<b>Nominal Impedance</b>	8 + 8 Ohms
<b>Amplifier Requirement</b>	20 - 100 W
<b>Continuous Power Handling</b>	100 W
<b>Sensitivity (1w @ 1m)</b>	88 dB
<b>Cut Out Size</b>	Ø 247 mm (9 3/4")
<b>Mounting Depth</b>	97.6 mm (3 7/8")
<b>IP Rating</b>	Front: IP55 Rear: IP4X
<b>Dimensions (Ø x D) inc. grille</b>	Ø 285 x 102.5 mm (Ø 11 1/4" x 4 1/8")
<b>Weight</b>	2.8 kg (6 lb 2 oz)





# Climate

The versatile Climate range ensures no environment is beyond the reach of great sound, whatever the weather! These speakers are certified to be resistant to UV, corrosion and water. Wall mounted in any combination, the Climate range provides a wide and even dispersion of full range sound over large areas. Low frequencies are augmented from an Auxiliary Bass Radiator (ABR) in each cabinet. They are available in a choice of paintable textured white or black finishes, and feature weatherproof aluminium grilles.

Operating temperature range: -25° to 65° C / -13° to 149° F.

Weather Resistant

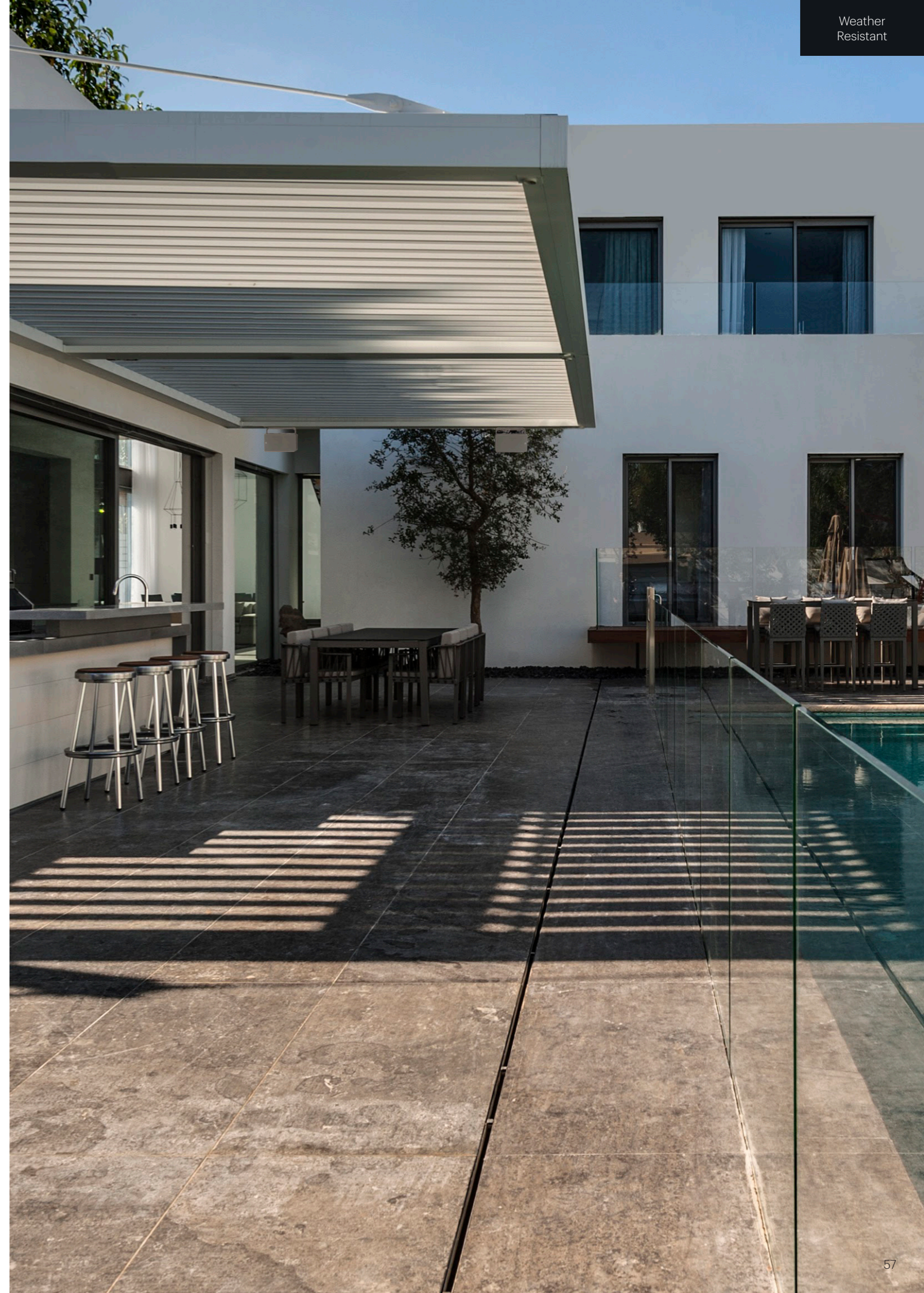

## Climate 50

<b>Drive Units Complement</b>	5 <sup>1/2</sup> " (140 mm) C-CAM mid-bass driver 1" (25mm) C-CAM tweeter ABR
<b>Nominal Impedance</b>	8 Ohms
<b>Amplifier Requirement</b>	10 – 80 W
<b>Continuous Power Handling</b>	80 W
<b>Sensitivity (1w @ 1m)</b>	87 dB
<b>IP Rating</b>	IP55
<b>Dimensions (H x W x D)</b>	285 x 172.5 x 158.5 mm (11 <sup>1/4</sup> " x 6 <sup>13/16</sup> " x 6 <sup>1/4</sup> "
<b>Weight</b>	3.66 kg (8 lb)
<b>Finishes</b>	White / Black



## Climate 60

<b>Drive Units Complement</b>	6 <sup>1/2</sup> " (165 mm) C-CAM mid-bass driver 1" (25mm) C-CAM tweeter ABR
<b>Nominal Impedance</b>	8 Ohms
<b>Amplifier Requirement</b>	15 – 100 W
<b>Continuous Power Handling</b>	100 W
<b>Sensitivity (1w @ 1m)</b>	88 dB
<b>IP Rating</b>	IP55
<b>Dimensions (H x W x D)</b>	325 x 185 x 178.5 mm (12 <sup>3/8</sup> " x 7 <sup>5/16</sup> " x 7"
<b>Weight</b>	4.62 kg (10 lb 2 oz)
<b>Finishes</b>	White / Black



## Climate 60-T2

<b>Drive Units Complement</b>	6 <sup>1/2</sup> " (165 mm) C-CAM mid-bass driver 1" (25mm) C-CAM tweeter ABR
<b>Nominal Impedance</b>	8 + 8 Ohms
<b>Amplifier Requirement</b>	15 – 100 W
<b>Continuous Power Handling</b>	2 x 50 W
<b>Sensitivity (1w @ 1m)</b>	88 dB
<b>IP Rating</b>	IP55
<b>Dimensions (H x W x D)</b>	325 x 185 x 178.5 mm (12 <sup>3/8</sup> " x 7 <sup>5/16</sup> " x 7"
<b>Weight</b>	5.02 kg (11 lb)
<b>Finishes</b>	White / Black



## Climate 80

<b>Drive Units Complement</b>	8" (203 mm) C-CAM mid-bass driver 1" (25mm) C-CAM tweeter ABR
<b>Nominal Impedance</b>	8 Ohms
<b>Amplifier Requirement</b>	20 – 120 W
<b>Continuous Power Handling</b>	120 W
<b>Sensitivity (1w @ 1m)</b>	89.5 dB
<b>IP Rating</b>	IP55
<b>Dimensions (H x W x D)</b>	405 x 230 x 221 mm (15 <sup>9/16</sup> " x 9 <sup>1/16</sup> " x 8 <sup>11/16</sup> "
<b>Weight</b>	6.53 kg (14 lb 6 oz)
<b>Finishes</b>	White / Black







# Specialist

## Special function, same great sound.

There are times when traditional custom installation loudspeakers need to be supplemented with highly specialised models designed to fulfil specific needs. At Monitor Audio we believe that performance shouldn't be compromised by function, which is why these specialist models offer sound quality on a par with more standard designs.

Explore Specialist  
speaker range at  
[monitoraudio.com](http://monitoraudio.com)





# IV140 Invisible Speaker

Bringing Monitor Audio's legendary expansive audio performance to any room, the IV140 couldn't be more discreet. Once installed and skimmed with plaster, the two-way speaker disappears completely out of view. Choose to finish the illusion with wallpaper or paint.

## Truly invisible sound

Concealed in-wall or in-ceilings, the speaker fits into all conventional 4" stud bays, leaving enough room for cabling. Once installed and skimmed with plaster, the speaker is completely out of sight, with paint, light wallpaper or fabric hiding it from view.

A large low-frequency transducer and two high frequency transducers provide punchy, high power bass and sound vibration. This two-way transducer design also features an integrated crossover to generate a wider frequency range and deliver crystal clear sound quality with smoother overall balance and character.

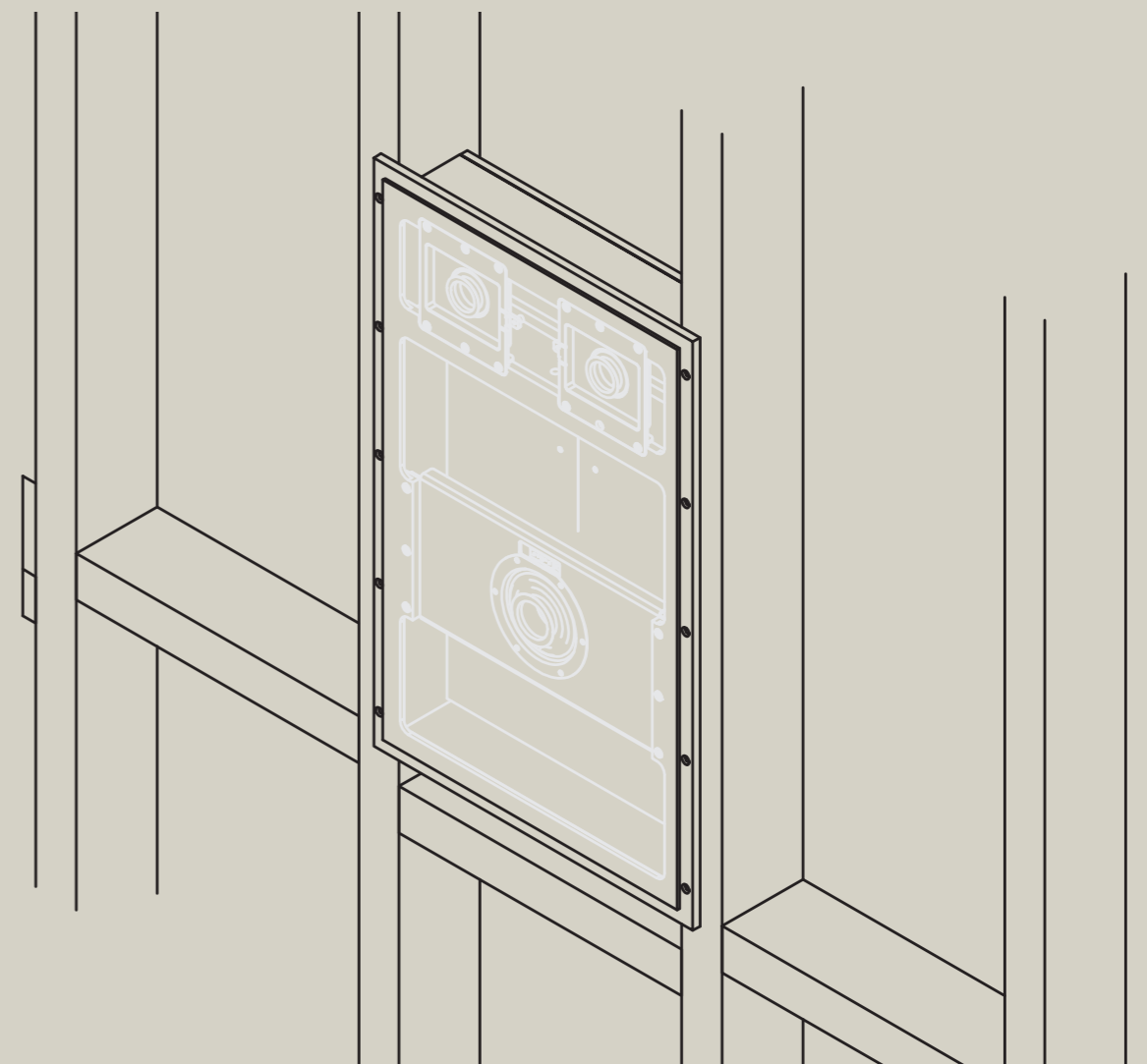

### IV140

<b>Drive Units Complement</b>	Low-Frequency transducer 2 x High-Frequency transducer
<b>Nominal Impedance</b>	8 Ohms
<b>Amplifier Requirement</b>	20-50 Watts (full range) 20-100 Watts (80 Hz High Pass filter)
<b>Continuous Power Handling</b>	50 Watts (full range) 100 Watts (80 Hz High Pass filter)
<b>Sensitivity (1w @ 1m)</b>	82 dB
<b>Cut Out Size</b>	591 x 350.5 mm
<b>Mounting Depth</b>	94 mm
<b>Dimensions (H x W x D)</b>	642 x 401.5 x 106 mm (25 1/4 x 15 3/16 x 4 3/16")
<b>Weight</b>	9 kg (20 lb)





# CF230 Flush Fit Speaker

For the last word in visual discretion consider the aesthetically attractive Flush Fit CF230 speaker. It's highly flexible and can be used on its own or in multiples. Set up as a 2.1 system with complementary ICS-8 subwoofer, it will outperform traditional Custom Install speakers.



## Flexible fitting options

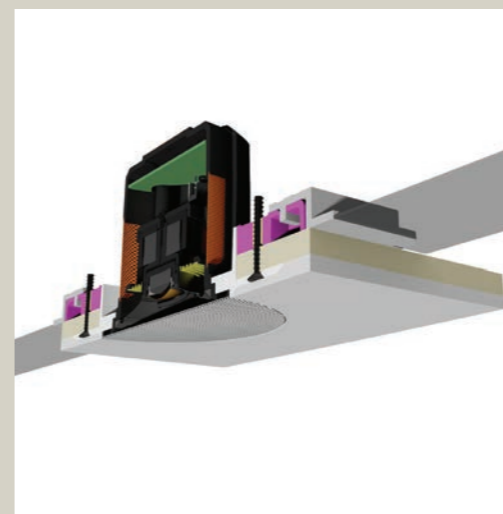

### Pre-Construction Flush-Fit

Once skimmed with plaster the pre-construction set-up CF230 package enables a seamless, flush fit appearance. You get clean lines, with no shadow-creating edges, and paint the grille to match the ceiling and the speaker disappears even further into the background. Available in either round or square options.

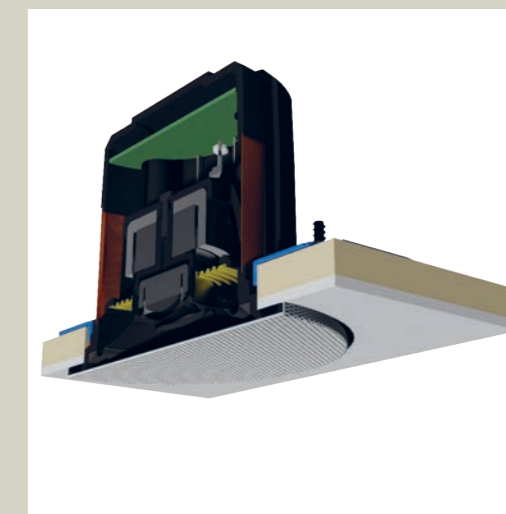

### Retro-Fit

The CFB3-KIT retrofit installation kit cleverly provides a firm fixing behind plasterboard/Sheetrock and requires just three bolts to complete the fit. The retrofit option is not flush fitting, but requires no plastering. The grille will sit slightly proud of the ceiling surface by 3.55 mm, less than a standard In-Ceiling grille.

CF230	
<b>Drive Units Complement</b>	3" <sup>1/2</sup> (89 mm) mid-bass C-CAM driver 3" <sup>1/2</sup> (19 mm) C-CAM Gold Dome tweeter
<b>Nominal Impedance</b>	8 Ohms
<b>Amplifier Requirement</b>	10-30 Watts (full range) 10-100 Watts (HP filter @120 Hz)
<b>Continuous Power Handling</b>	30 Watts (full range) 100 Watts (HP filter @120 Hz)
<b>Sensitivity (2.83v @ 1m)</b>	82.5 dB
<b>Cut Out Size</b>	Flush Fit Ø 120 mm (4 3/4") Retrofit Ø 90 mm (3 5/8")
<b>Mounting Depth</b>	81.5 mm (3 1/8")
<b>Dimensions (Ø x D) inc. grille</b>	Ø 112 x 83.62 mm (Ø 4 7/16 x 3 5/16")
<b>Weight</b>	0.44 kg (1 lb)



CFB3-R (Round)  
Flush Fit Bracket

CFB3-SQ (Square)  
Flush Fit Bracket



CFB3-KIT  
Retro-Fit Bracket





# CPC120

A precision engineered micro design; the CPC120 loudspeaker offers extraordinary sound quality from a standard GU10-sized halogen down-lighter hole. It fits into ceilings with conventional fitment clips meaning quick and simple installation.

## CPC120

<b>Drive Units Complement</b>	2" (51 mm) Full range micro-driver
<b>Nominal Impedance</b>	8 Ohms
<b>Amplifier Requirement</b>	5 - 20 W 5 - 50 W (using crossover)
<b>Continuous Power Handling</b>	20 W 50 W (using crossover)
<b>Sensitivity (1w @ 1m)</b>	85 dB
<b>Cut Out Size</b>	Ø 65 mm (2 1/2")
<b>Mounting Depth</b>	91.5 mm (3 5/8")
<b>Dimensions (Ø x D) inc. grille</b>	Ø 80 x 96 mm (Ø 3 1/8" x 3 3/8")
<b>Weight</b>	0.19 kg (0.42 lb)







# Custom Subwoofers

## All the bass, none of the box

Designed to perfectly complement our architectural speakers, the Monitor Audio Custom Subwoofer range brings added bass reach, yet demands little in the way of footprint. Choose from our ultra-compact in-ceiling or in-wall models.



Explore Custom  
Subwoofers at  
[monitoraudio.com](https://www.monitoraudio.com)





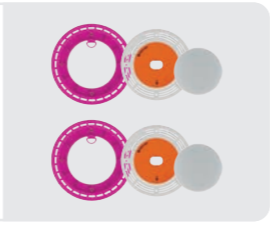

# ICS-8 In-Ceiling

This high-performance passive subwoofer is engineered to fit into discreet spaces, such as ceiling and wall cavities. The ICS-8 was primarily developed to complement the CF230 flush fit in-ceiling speaker, but can be used in other systems.

<b>ICS-8</b>			<b>CFB3-R (Round) Bracket</b>  <b>CFB3-SQ (Square) Bracket</b>
<b>Drive Units Complement</b>	7 <sup>1/8</sup> " (200 mm) C-CAM long throw bass driver		
<b>Nominal Impedance</b>	8 Ohms		
<b>Amplifier Requirement</b>	150 W		
<b>Continuous Power Handling</b>	150 W (full range - IEC268-5 rating)		
<b>Sensitivity (1w @ 1m)</b>	85 dB		
<b>Cut Out Size</b>	Ø 120 mm (4 3/4")		
<b>Box Dimensions (H x W x D)</b>	396 x 280 x 235 mm (15 <sup>5/8</sup> x 11 x 9 <sup>1/4</sup> ")		
<b>Vent Dimensions (L x Ø)</b>	427 mm (long) x 75 mm (DIA)		
<b>Weight</b>	10.2 kg (22 lb 8 oz)		
			
			<b>CFB3-KIT Bracket</b>

# IWS-10 In-Wall

The IWS-10 is specified to produce excellent bass quality in a range of wall, ceiling, even floor locations, ideally but not exclusively with its IWB-10 back box.

<b>IWS-10</b>			<b>IWA-250</b>
<b>Drive Units Complement</b>	10" (252 mm) C-CAM RDT driver		
<b>Nominal Impedance</b>	8 Ohms		
<b>Continuous Power Handling</b>	150 W		
<b>Sensitivity (1w @ 1m)</b>	86 dB		
<b>Cut Out Size</b>	280 x 280 mm (11 x 11")		
<b>Mounting Depth</b>	89.98 mm (3 1/2")		
<b>Dimensions (H x W x D) inc grille</b>	314 x 314 x 100 mm (12 <sup>3/8</sup> x 12 <sup>3/8</sup> x 3 <sup>9/16</sup> ")		
<b>Weight</b>	3.8 kg (8 lb 6 oz)		
			
		<b>IWB-10 Backbox</b>	

<b>IWB-10 Backbox</b>	
	







# Streamers & Amplifiers

## Superior power for your home cinema or multi-room installation

Behind every great home cinema or multi-room installation is smart and powerful amplification. That's why every model in Monitor Audio's comprehensive range of high-performance amplifiers is capable of delivering precise, head-turning power in the blink of an eye, for a dynamic experience with movies, music or the big match, inside or even outside in a garden system.

Engineered to deliver a pristine performance, they benefit from robust build, intuitive technologies and comprehensive connection options. They are the perfect partners for our IMS-4 music streamer, which uses BluOS™ technology and can play music in up to four separate zones.

Explore Streamers  
and Amplifiers at  
[monitoraudio.com](https://www.monitoraudio.com)





# Key Features



## Technology that works for you

Our range of custom installation amplifiers come with plentiful reserves of power as standard. That power is complemented by installer-friendly technologies that deliver brains alongside the brawn. On our newest amplifiers these technologies include DSP matrix configuration and flexible power options, which allow you to use your amplifier's power the way you need it.

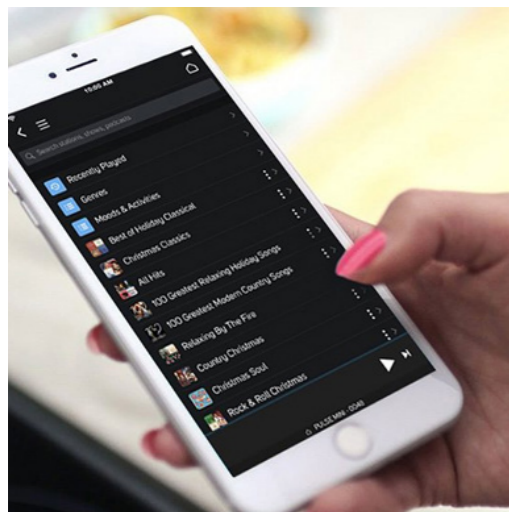
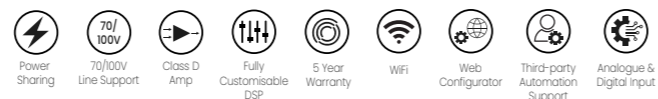

## BluOS

BluOS is a wireless ecosystem that uses a home network to connect more than one enabled device and play your music in perfect sync, or different music simultaneously, anywhere in the house. Using advanced technologies, BluOS can wirelessly transmit lossless music up to 24-bit/192kHz at lightning-fast speeds with no lag and zero loss in sound quality.

BluOS



## Flexibility built in

Our comprehensive range of amplifiers means that whatever your requirements we have the products for your project. Not only are they powerful enough to drive the largest of home theatre systems, they are smart enough to maximise performance no matter how involved your multi-room system is. And with all the industry standard connections on offer, there's no need to worry about compatibility either.

# Designed for installation

Each and every amplifier Monitor Audio manufactures is engineered with custom installation projects in mind. Beyond power and installer-friendly technologies, they are also quick and easy to fit, and their discreet form ensures they use the minimum amount of space. They also support a wide range of connectivity options, and their rugged design is engineered to last. Whatever they project, we have the custom installation amplifiers for you.

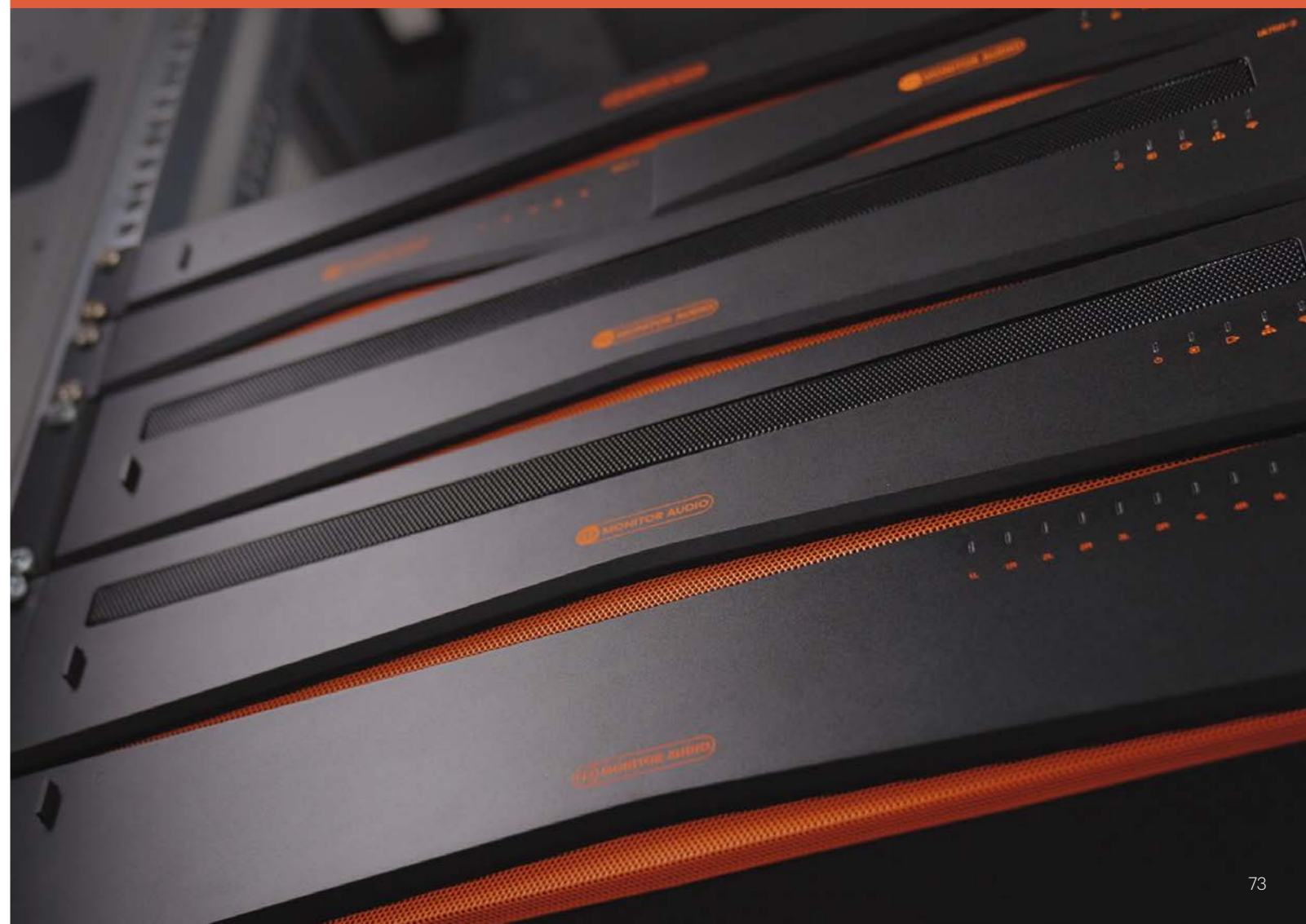



### IMS-4

<b>Channels</b>	4
<b>IP Control</b>	BluOS
<b>Sample Rate</b>	Up to 24-bit/ 192 kHz
<b>Signal to Noise Ratio</b>	110 dBA
<b>Inputs</b>	Analogue - RCA Stereo Digital SPDIF - Optical (TOSLINK) USB - Type A (FAT32 Formatted)
<b>Outputs</b>	Analogue - 4 x RCA Stereo Digital SPDIF - 4 x Optical (TOSLINK) 4 x Coaxial
<b>Dimensions (H x W x D)</b>	45.1 x 438 x 236.1 mm (1 3/8" x 17 1/8" x 9 5/16")
<b>Rack Height</b>	1 U



### IA60-4

<b>Channels</b>	4
<b>Output Power @ 4 Ohms/8 Ohms</b>	4 x 60W Single Ended
<b>Output Power @ 70/100V</b>	2 x 125W Bridge Tied Load
<b>Signal to Noise Ratio</b>	>106dB (A-weighted, 20 Hz - 20 kHz, 8 Ohm load)
<b>THD+N (typical)</b>	<0.05% (20 Hz - 20 kHz, 8 Ohm load, 3db below rated power)
<b>Dimensions (H x W x D)</b>	44 x 220 x 325 mm (1 3/4" x 8 11/16" x 12 11/16")
<b>Rack Height</b>	1 U



### IA125-4

<b>Channels</b>	4
<b>Output Power @ 4 Ohms/8 Ohms</b>	4 x 125W Single Ended
<b>Output Power @ 70/100V</b>	2 x 250 Bridge Tied Load
<b>Signal to Noise Ratio</b>	>106dB (A-weighted, 20 Hz - 20 kHz, 8 Ohm load)
<b>THD+N (typical)</b>	<0.05% (20 Hz - 20 kHz, 8 Ohm load, 3db below rated power)
<b>Dimensions (H x W x D)</b>	44 x 220 x 325 mm (1 3/4" x 8 11/16" x 12 11/16")
<b>Rack Height</b>	1 U



### IA750-2

<b>Channels</b>	2
<b>Output Power @ 4 Ohms/8 Ohms</b>	2 x 750W Single Ended
<b>Output Power @ 70/100V</b>	2 x 750W Single Ended, 1 x 1500W Bridge Tied Load
<b>Signal to Noise Ratio</b>	>108dB (A-weighted, 20Hz - 20kHz, 8 Ohm load)
<b>THD+N (typical)</b>	<0.05% (20 Hz - 20 kHz, 8 Ohm load, 3db below rated power)
<b>Dimensions (H x W x D)</b>	88 x 440 x 329 mm (3 5/16" x 17 1/16" x 12 11/16")
<b>Rack Height</b>	2 U



### IA750-4

<b>Channels</b>	4
<b>Output Power @ 4 Ohms</b>	4 x 750W Single Ended, 2 x 1500W Bridge Tied Load
<b>Output Power @ 70V</b>	1 x 1200W Bridge Tied Load
<b>Signal to Noise Ratio</b>	>108dB (A-weighted, 20Hz - 20kHz, 8 Ohm load)
<b>THD+N (typical)</b>	<0.05% (20 Hz - 20 kHz, 8 Ohm load, 3db below rated power)
<b>Dimensions (H x W x D)</b>	88 x 440 x 329 mm (3 5/16" x 17 1/16" x 12 11/16")
<b>Rack Height</b>	2 U



### IA60-12

<b>Channels</b>	12
<b>Output Power @ 4 Ohms</b>	60 W
<b>Signal to Noise Ratio</b>	-100 dB (20 Hz - 20 kHz)
<b>THD+N (typical)</b>	0.03%
<b>Dimensions (H x W x D)</b>	97.2 x 438 x 427 mm (3 13/16" x 17 1/4" x 16 13/16")
<b>Rack Height</b>	2 U



### Installation Amplifier Rack Kit



### Installation Amplifier Wall/Desk Kit



### Recommended Usage

IA750-2 and IA750-4 are the perfect installation amplifier to power Cinergy cinema systems.





# Soundbars

## TV sound, enhanced

The perfect partners for larger flatscreen TVs, our collection of passive soundbars complement your HD picture with the high-definition sound you've been missing, and match the look of your TV with their contemporary design. Whether you are streaming the latest hit TV series or watching your favourite Hollywood blockbuster, the addition of a high-definition soundbar will elevate your enjoyment to a whole new level.

Explore Subwoofers  
at [monitoraudio.com](https://www.monitoraudio.com)





# Passive Soundbars

Our passive soundbars add breath-taking high-definition audio to big-screen TVs of 50 inches and above. The three super-slim SB models are engineered with flagship cabinet and driver technologies to combine efficient low-profile design with extraordinary room-filling dynamics, and come with a wide range of mounting options for easy and discreet custom installation.

## SB-2

<b>Drive Units Complement</b>	3 x 4" (102 mm) C-CAM bass drivers 3 x 1" (25 mm) C-CAM dome tweeter
<b>Nominal Impedance</b>	8 Ohms
<b>Amplifier Requirement</b>	30 – 100 W
<b>Continuous Power Handling</b>	100 W
<b>Sensitivity (1w @ 1m)</b>	84 dB
<b>Dimensions (H x W x D)</b>	147 x 1107 x 93 mm (5 <sup>13/16</sup> x 43 <sup>9/16</sup> x 3 <sup>11/16</sup> )
<b>Weight</b>	764 kg (16 lb 12 oz)



## SB-3

<b>Drive Units Complement</b>	Left & Right Channels 2 x 4" (102 mm) C-CAM bass drivers 2 x 1" (25 mm) C-CAM dome tweeter Centre Channel 2 x 4" (102 mm) C-CAM bass drivers 1 x 1" (25 mm) C-CAM dome tweeter
<b>Nominal Impedance</b>	8 Ohms
<b>Amplifier Requirement</b>	30 – 100 W
<b>Continuous Power Handling</b>	100 W
<b>Sensitivity (1w @ 1m)</b>	Left and Right Channels: 84 dB Centre Channel: 87 dB
<b>Dimensions (H x W x D)</b>	147 x 1307 x 93 mm (5 <sup>13/16</sup> x 51 <sup>7/16</sup> x 3 <sup>11/16</sup> )
<b>Weight</b>	91 kg (20 lb)



## SB-4

<b>Drive Units Complement</b>	All Channels 2 x 4" (102 mm) C-CAM bass drivers 2 x 1" (25 mm) C-CAM dome tweeter
<b>Nominal Impedance</b>	8 Ohms
<b>Amplifier Requirement</b>	30 – 100 W
<b>Continuous Power Handling</b>	100 W
<b>Sensitivity (1w @ 1m)</b>	87 dB
<b>Dimensions (H x W x D)</b>	147 x 1562 x 92 mm (5 <sup>13/16</sup> x 61 <sup>15/16</sup> x 3 <sup>11/16</sup> )
<b>Weight</b>	12 kg (26 lb 7 oz)



## BSB Bracket

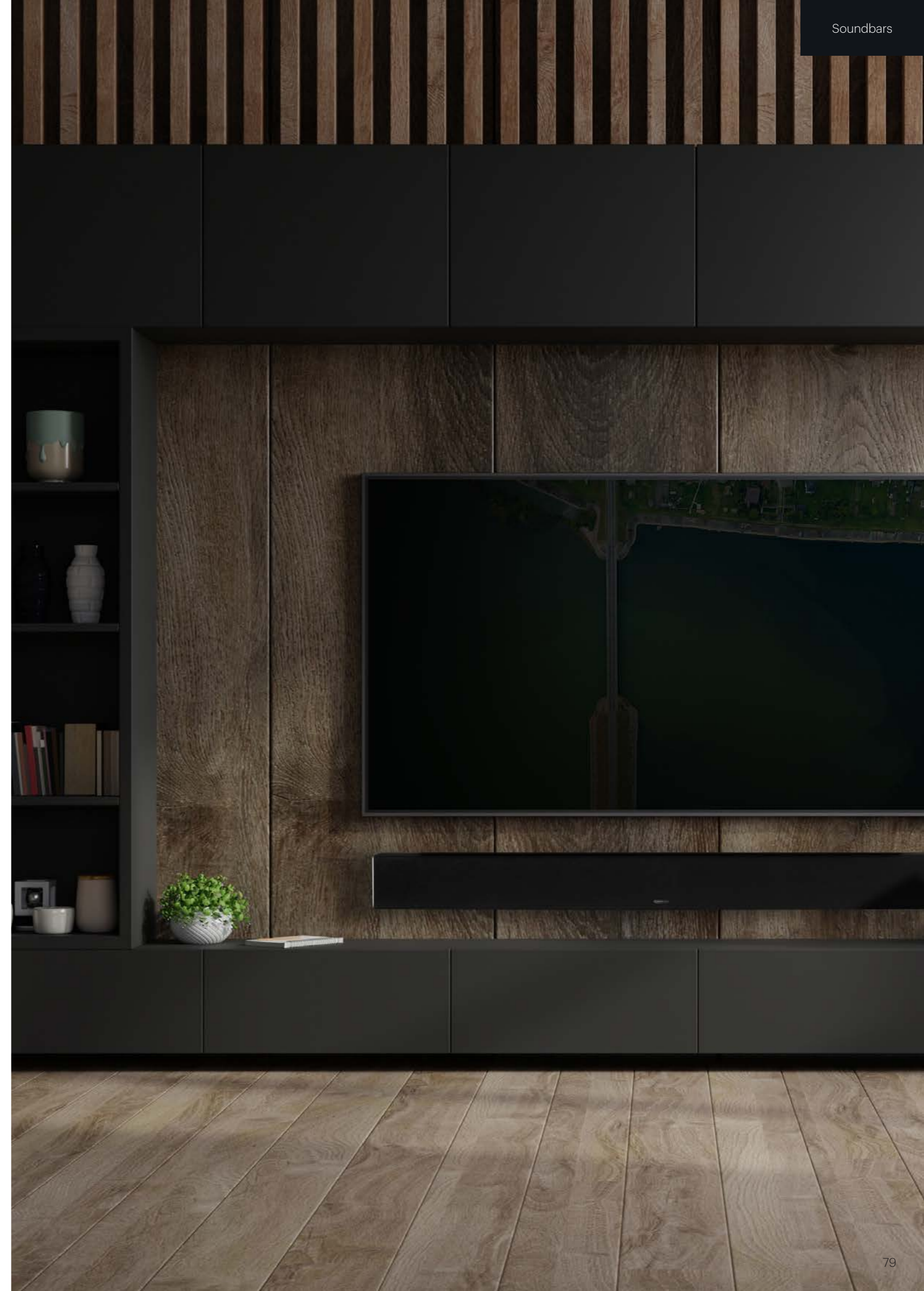





# SoundFrame

## Our speakers, your way

The SoundFrame range comprises easy to install on-wall and in-wall models, with pivoting IDC modules perfect for creating the ideal audio balance, while a wide range of grille colours, images and custom grille designs allow you to create your own look. Keyhole fixings for on-wall and pre-fix corner brackets for the in-wall models make for a simple set up. And because the connecting cable runs in the wall cavity, enters from the back and is connected at the front, you are guaranteed a stylish wire-free finish.

Explore SoundFrame  
at [monitoraudio.com](https://www.monitoraudio.com)





# Key Features

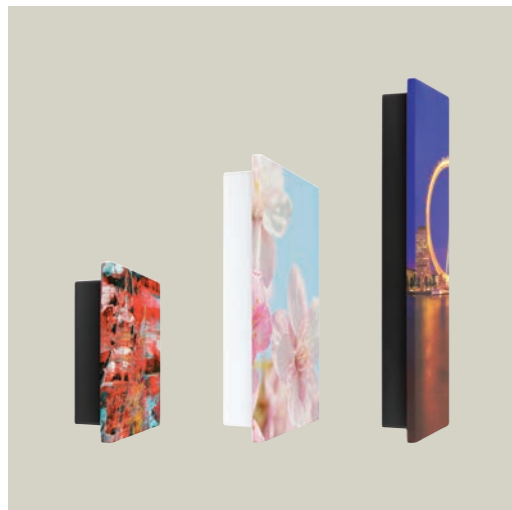

## Frameless or Framed

As standard SoundFrame includes a lacquered gloss white or gloss black frame in the box, along with a corresponding grille. Want to ditch the frame? Choose to upgrade to a frameless grille, giving SoundFrame a canvas print look.



## High performance

We've utilised our most advanced driver technologies to raise the quality of on-wall/in-wall speaker performance. Music and film sound, rich in detail and dynamic impact, is delivered by a true 3-way full-range driver configuration featuring a pivoting Inverted Dual Concentric (IDC) 4-inch mid-range/1-inch tweeter module and an 6.5-inch C-CAM bass driver (SoundFrame 1 & SoundFrame 2).



## Sizes for any application

SoundFrame is an ultra-discreet loudspeaker available in a choice of three models, each with an on-wall or in-wall option. SF1 has a portrait aspect ratio; SF2, a longer landscaped look, and SF3 is a diminutive square-shaped surround speaker. SoundFrame's white or black matte cabinet has been developed to sit stylishly around wall-mounted TVs for captivating home theatre sound, or in pairs as part of a high quality music system

# Customising your SoundFrame Grilles

## Ordering from the additional Grille Gallery

If you are looking to personalise your SoundFrame loudspeakers, we have an expertly curated collection of grille images and colours to choose from, and which can be used on all three models. They are shown in the gallery overviews displayed by product size. Simply take note of the reference number shown below your chosen grille(s) and order them from your local Monitor Audio dealer. Though some grilles are shown in pairs, they're individually numbered, so you can order the combination of images or colours that's right for you. State if you require 'framed' or 'frameless' when ordering.

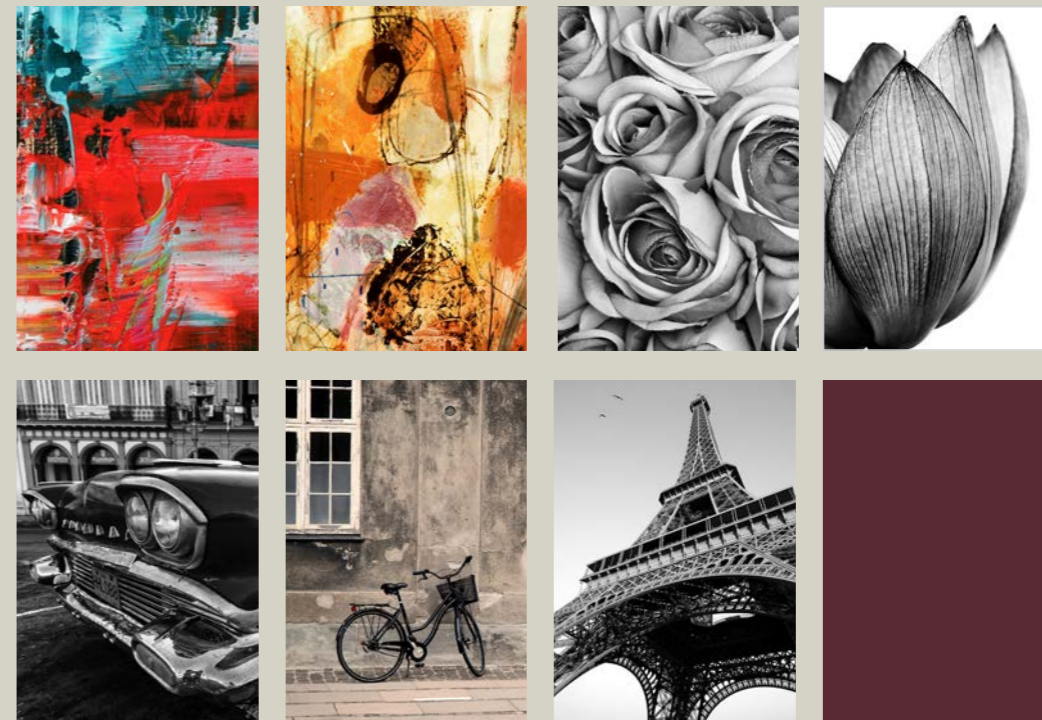

## Commissioning an additional Bespoke Grille

In addition to the curated SoundFrame grille options, you can also create their own design for your SoundFrame grille. You can use your favourite photo or your own artwork, (provided you have the rights to use it). You can supply your local Monitor Audio dealer with a print-ready image, which will then be printed onto your SoundFrame grille and supplied by your dealer. Please note that any design will need to fit the shape and size of the selected SoundFrame with enough additional image around its sides to be able to wrap around the wooden frame template.





On-Wall

SoundFrame 1

<b>Drive Units Complement</b>	6 1/2" (165 mm) C-CAM RST bass drivers 4" (102 mm) IDC mid-range driver with dual concentric 1" (25 mm) C-CAM Gold Dome tweeter
<b>Nominal Impedance</b>	8 Ohms
<b>Amplifier Requirement</b>	25 – 100 W
<b>Continuous Power Handling</b>	100 W
<b>Sensitivity (1w @ 1m)</b>	86 dB
<b>Dimensions (H x W x D)</b>	539 x 389 x 87.5 mm (21 1/4" x 15 3/16" x 3 7/16")
<b>Weight</b>	7.44 kg (16.37 lbs)
<b>Finishes</b>	Gloss White / Gloss Black



SoundFrame 2

<b>Drive Units Complement</b>	6 1/2" (165 mm) C-CAM RST bass drivers 4" (102 mm) IDC mid-range driver with dual concentric 1" (25 mm) C-CAM Gold Dome tweeter
<b>Nominal Impedance</b>	8 Ohms
<b>Amplifier Requirement</b>	25 – 100 W
<b>Continuous Power Handling</b>	100 W
<b>Sensitivity (1w @ 1m)</b>	86 dB
<b>Dimensions (H x W x D)</b>	790 x 240 x 87.5 mm (31 1/8" x 9 7/16" x 3 7/16")
<b>Weight</b>	7.06 kg (15.53 lbs)
<b>Finishes</b>	Gloss White / Gloss Black



SoundFrame 3

<b>Drive Units Complement</b>	4" (102 mm) MMP II mid-bass drivers 1" (25 mm) C-CAM Gold Dome tweeter
<b>Nominal Impedance</b>	8 Ohms
<b>Amplifier Requirement</b>	25 – 50 W
<b>Continuous Power Handling</b>	50 W
<b>Sensitivity (1w @ 1m)</b>	86 dB
<b>Dimensions (H x W x D)</b>	289 x 289 x 77.5 mm (11 3/8" x 11 3/8" x 3")
<b>Weight</b>	2.76 kg (6 lbs)
<b>Finishes</b>	Gloss White / Gloss Black



In-Wall

SoundFrame 1

<b>Drive Units Complement</b>	6 1/2" (165 mm) C-CAM RST bass drivers 4" (102 mm) IDC mid-range driver with dual concentric 1" (25 mm) C-CAM Gold Dome tweeter
<b>Nominal Impedance</b>	8 Ohms
<b>Amplifier Requirement</b>	25 – 100 W
<b>Continuous Power Handling</b>	100 W
<b>Sensitivity (1w @ 1m)</b>	86 dB
<b>Cut Out Size</b>	501 x 351 mm (19 3/4" x 13 13/16")
<b>Dimensions (H x W x D)</b>	552 x 402 x 87.5 mm (21 3/8" x 15 7/16" x 3 7/16")
<b>Weight</b>	7.53 kg (16.6 lbs)
<b>Finishes</b>	Gloss White / Gloss Black



SoundFrame 2

<b>Drive Units Complement</b>	6 1/2" (165 mm) C-CAM RST bass drivers 4" (102 mm) IDC mid-range driver with dual concentric 1" (25 mm) C-CAM Gold Dome tweeter
<b>Nominal Impedance</b>	8 Ohms
<b>Amplifier Requirement</b>	25 – 100 W
<b>Continuous Power Handling</b>	100 W
<b>Sensitivity (1w @ 1m)</b>	86 dB
<b>Cut Out Size</b>	751 x 201 mm (29 5/8" x 7 15/16")
<b>Dimensions (H x W x D)</b>	802.5 x 252.5 x 87.5 mm (31 5/8" x 9 7/16" x 3 7/16")
<b>Weight</b>	7.26 kg (16 lbs)
<b>Finishes</b>	Gloss White / Gloss Black



SoundFrame 3

<b>Drive Units Complement</b>	4" (102 mm) MMP II mid-bass drivers 1" (25 mm) C-CAM Gold Dome tweeter
<b>Nominal Impedance</b>	8 Ohms
<b>Amplifier Requirement</b>	25 – 50 W
<b>Continuous Power Handling</b>	50 W
<b>Sensitivity (1w @ 1m)</b>	86 dB
<b>Cut Out Size</b>	251 x 251 mm (9 7/8" x 9 7/8")
<b>Dimensions (H x W x D)</b>	301.5 x 301.5 x 77.5 mm (11 7/8" x 11 7/8" x 3 1/8")
<b>Weight</b>	3 kg (6.6 lbs)
<b>Finishes</b>	Gloss White / Gloss Black





# Basics

Part of the wider Creator Series, the Monitor Audio Basics selection of In-Wall and In-Ceiling architectural speakers offers an affordable entry point into the series. The models combine a no-frills approach to the concept of installation loudspeakers, and the key Monitor Audio acoustic technologies they each house.

Using C-CAM gold dome tweeters and MMP II mid/bass driver technologies, along with robust dog-leg fixings and sleek overall designs, hassle-free installation is guaranteed, as is the the pristine, lifelike sound performance they produce.

## C165

<b>Drive Units Complement</b>	6 1/2" (165 mm) MMP II bass driver 1" (25 mm) C-CAM Gold Dome tweeter
<b>Nominal Impedance</b>	6 Ohms
<b>Amplifier Requirement</b>	20 - 65 W
<b>Continuous Power Handling</b>	65 W
<b>Sensitivity (2.83v @ 1m)</b>	88.5 dB
<b>Cut Out Size</b>	Ø 211 mm (8 3/16")
<b>Mounting Depth</b>	116 mm (4 5/16")
<b>Dimensions (Ø x D) inc. grille</b>	Ø 250 x 120 mm (Ø 9 13/16 x 4 3/4")
<b>Weight</b>	1.9 kg (4 lb 4 oz)



## C180

<b>Drive Units Complement</b>	8" (203 mm) MMP II bass driver 1" (25 mm) C-CAM Gold Dome tweeter
<b>Nominal Impedance</b>	6 Ohms
<b>Amplifier Requirement</b>	30 - 120 W
<b>Continuous Power Handling</b>	120 W
<b>Sensitivity (2.83v @ 1m)</b>	90 dB
<b>Cut Out Size</b>	Ø 247 mm (9 3/4")
<b>Mounting Depth</b>	122 mm (4 13/16")
<b>Dimensions (Ø x D) inc. grille</b>	Ø 285 x 126 mm (Ø 11 1/4 x 4 9/16")
<b>Weight</b>	2.7 kg (6 lb)



## W165

<b>Drive Units Complement</b>	6 1/2" (165 mm) MMP II bass driver 1" (25 mm) C-CAM Gold Dome tweeter
<b>Nominal Impedance</b>	6 Ohms
<b>Amplifier Requirement</b>	20 - 65 W
<b>Continuous Power Handling</b>	65 W
<b>Sensitivity (2.83v @ 1m)</b>	88.5 dB
<b>Cut Out Size</b>	332 x 213 mm (13 1/8 x 8 3/8")
<b>Mounting Depth</b>	92 mm (3 5/8")
<b>Dimensions (H x W x D) inc. grille</b>	370 x 250 x 96 mm (14 5/8 x 9 13/16 x 3 3/4")
<b>Weight</b>	2.2 kg (4 lb 14 oz)



## W180

<b>Drive Units Complement</b>	8" (203 mm) MMP II bass driver 1" (25 mm) C-CAM Gold Dome tweeter
<b>Nominal Impedance</b>	6 Ohms
<b>Amplifier Requirement</b>	30 - 120 W
<b>Continuous Power Handling</b>	120 W
<b>Sensitivity (2.83v @ 1m)</b>	90 dB
<b>Cut Out Size</b>	387 x 234 mm (15 1/4 x 9 3/16")
<b>Mounting Depth</b>	100 mm (3 5/16")
<b>Dimensions (H x W x D) inc. grille</b>	441 x 288 x 104 mm (17 3/8 x 11 3/16 x 4 1/8")
<b>Weight</b>	3 kg (6 lb 12 oz)





# Accessories

## Pre-construction brackets

CS-B



Compatible with:  
C1S, C2S

CM-B



Compatible with:  
C1M, C2M, C2M-T2X,  
C2M-CP, C3M, CSS230,  
AWC265, AWC265-T2,  
C165 (plus previous 6.5"  
in-ceiling speakers)

CL-B



Compatible with:  
C1L, C2L, C2L-T2X, C2L-CP,  
C3L, C3L-CP, C3L-A,  
AWC280, AWC280-T2,  
C180 (plus previous 8"  
in-ceiling speakers)

CB10



Compatible with:  
PLIC II (plus previous 10"  
in-ceiling speakers)

WM-B



Compatible with:  
W1M-E, W1M, W2M,  
W2M-CP, W3M

WB3



Compatible with:  
WSS130, WSS230,  
WSS430

WB6

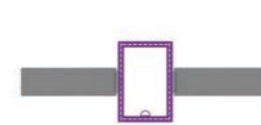

Compatible with:  
W165

WB8

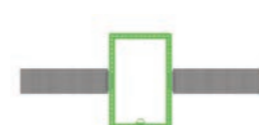

Compatible with:  
W180

WB12



Compatible with:  
CP-IW260X, CP-IW460X

WBIV140



Compatible with:  
IV140

## Back Boxes

CSM-BOX



Compatible with:  
C1S, C2S, C1M, C2M,  
C2M-T2X, C2M-CP,  
C3M, CSS230, AWC265,  
AWC265-T2, C165  
(plus previous 6.5"  
in-ceiling speakers)

CML-BOX



Compatible with:  
C3M, CSS230, AWC265,  
AWC265-T2, C165, C1L,  
C2L, C2L-T2X, C2L-CP,  
C3L, C3L-CP, C3L-A,  
AWC280, AWC280-T2,  
C180 (plus previous 6.5"  
& 8" in-ceiling speakers)

WM-BOX



Compatible with:  
W1M-E, W1M, W2M,  
W2M-CP, W3M

PLIC-BOX II



Compatible with:  
PLIC II

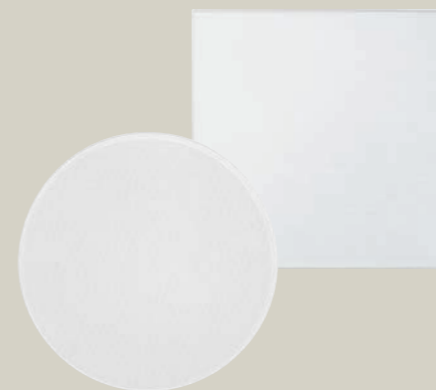

## Square & Replacement Grilles

We offer optional square grilles for a selection of our In-Ceiling speakers.

Replacement circular grilles are also available.

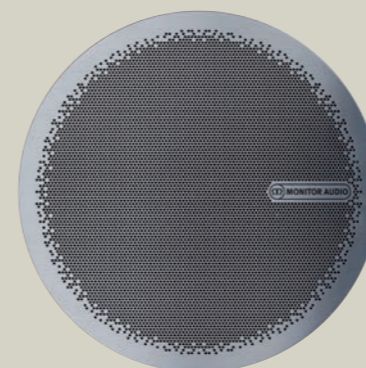

## Premium Grille PG6-R

The Premium Grille has been designed and developed to add a stylish aesthetic to Monitor Audio Custom Install speakers. The hexagonal pattern dissipates towards the edge of the grille to create a subtle design effect, whilst allowing maximum audio performance from the speaker. Crafted from magnetised stainless steel, the PG6-R Premium Grille offers an instant retro-fit solution.

PG6-R fits M size Creator Series speakers and our previous 6.5" speakers.

# Explore more accessories

Find our entire accessories range at [monitoraudio.com](http://monitoraudio.com)



All-Weather

Application	In-Ceiling			
Model Name	AWC265	AWC265-T2	AWC280	AWC280-T2
Sensitivity (1W@1m)	88 dB	88 dB (both channels driven)	89 dB	89 dB (both channels driven)
Cut Out Size	Ø 211 mm (8 <sup>1/4"</sup> )	Ø 211 mm (8 <sup>1/4"</sup> )	Ø 247 mm (9 <sup>3/4"</sup> )	Ø 247 mm (9 <sup>3/4"</sup> )
Mounting Depth	88.5 mm (3 <sup>1/2"</sup> )	88.5 mm (3 <sup>1/2"</sup> )	97.6 mm (3 <sup>7/8"</sup> )	97.6 mm (3 <sup>7/8"</sup> )
External Dimensions Inc Grilles (Ø x D)	Ø 251.7 x 93.5 mm (Ø 9 <sup>9/16</sup> x 3 <sup>1/2"</sup> )	Ø 251.7 x 93.5 mm (Ø 9 <sup>9/16</sup> x 3 <sup>1/2"</sup> )	Ø 285 x 102.5 mm (Ø 11 <sup>1/4</sup> x 4 <sup>1/8"</sup> )	Ø 285 x 102.5 mm (Ø 11 <sup>1/4</sup> x 4 <sup>1/8"</sup> )
Recommended Amp Requirements	20 – 60 W	20 – 60 W	20 – 100 W	20 – 100 W
Power Handling (RMS)	60 W	60 W	100 W	100 W
Nominal Impedance	8 Ohms (4.4 Ohms @ 190 Hz)	8 + 8 Ohms (4.5 Ohms @ 185 Hz)	8 Ohms 4.5 Ohms @ 185 Hz	8 + 8 Ohms 4.5 Ohms @ 185 Hz
Drive Unit Complement	165 mm (6 <sup>1/2"</sup> ) C-CAM mid-bass driver 25 mm (1") C-CAM tweeter	165 mm (6 <sup>1/2"</sup> ) C-CAM mid-bass driver 2 x 25 mm (1") C-CAM tweeter	203 mm (8") C-CAM mid-bass driver 25 mm (1") C-CAM tweeter	203 mm (8") C-CAM mid-bass driver 2 x 25 mm (1") C-CAM tweeter
Frequency Response	60 Hz – 30 kHz	60 Hz – 30 kHz	50 Hz – 30 kHz	50 Hz – 30 kHz
Maximum SPL	105.8 dBA	105.8 dBA	109 dBA	109 dBA
Additional Square Grilles Dimensions	249 mm (9 <sup>3/4"</sup> )	249 mm (9 <sup>3/4"</sup> )	285 mm (11 <sup>1/4"</sup> )	285 mm (11 <sup>1/4"</sup> )
HF Level Switch (+3 dB/0 dB/-3 dB)	Yes	Yes	Yes	Yes
Construction Material	Mineral Filled PC-ABS Polymer (UL V0 Fire Retardant, RoHS2 Compliant) SS430 Stainless Steel / Samarium Cobalt	Mineral Filled PC-ABS Polymer (UL V0 Fire Retardant, RoHS2 Compliant) SS430 Stainless Steel / Samarium Cobalt	Mineral Filled PC-ABS Polymer (UL V0 Fire Retardant, RoHS2 Compliant) SS430 Stainless Steel / Samarium Cobalt	Mineral Filled PC-ABS Polymer (UL V0 Fire Retardant, RoHS2 Compliant) SS430 Stainless Steel / Samarium Cobalt
Operating Temperature Range	-34° to 79° C -29° to 174° F	-34° to 79° C -29° to 174° F	-34° to 79° C -29° to 174° F	-34° to 79° C -29° to 174° F
IP Ratings	IP55	IP55	IP55	IP55
Weight	2.14 kg (4 lb 12 oz)	2.14 kg (4 lb 12 oz)	2.8 kg (6 lb 2 oz)	2.8 kg (6 lb 2 oz)
Pre-Construction Bracket	CM-B	CM-B	CL-B	CL-B
Back Box	CSM-BOX	CSM-BOX	CML-BOX	CML-BOX

Amplifiers & Streamers

Application	Rack Mounted				Application	Rack Mounted / Free Standing	
Model Name	IA60-4	IA125-4	IA750-2	IA750-4	IA60-12	Model Name	IMS-4
Channels	4	4	2	4	12 (6 Stereo Pairs)	IP Control	BluOS™
Output Power @ 4 Ohms/8 Ohms	4 x 60W SE*	4 x 125W SE	N/A	N/A	N/A	Channel Number/ Rooms	4 Rooms
Output Power @ 70/100V	2 x 125W BTL**	2 x 250 BTL	N/A	N/A	N/A	Maximum Input Voltage (RMS)	2.2 V
Output power @2 Ohms	N/A	N/A	2 x 750W SE	4 x 750W SE	-	Signal to noise (S:N Ratio)	110 dBA
Output Power @ 4 Ohms	N/A	N/A	2 x 750W SE, 1 x 1500W BTL	4 x 750W SE, 2 x 1500W BTL	60 W	Rack Height	1U
Output Power @ 8 Ohms	N/A	N/A	2 x 400W SE, 1 x 1500W BTL	2 x 400W SE, 2 x 1500W BTL	45W (Bridged 100 W (6CH)	Dimensions (Without feet) (H x W x D)	47 x 438 x 238 mm (1 <sup>7/8</sup> x 17 <sup>1/8</sup> x 9 <sup>3/8"</sup> )
Output Power @ 70V	N/A	N/A	1 x 1200W BTL	1 x 1200W BTL	-	Weight	2.8 kg / 6 lb 3 oz
Output Power @ 100V	N/A	N/A	1 x 1500W BTL	2 x 1500W BTL	-	IP	TCP/IP (RJ-45 10/100 Base T)
Poweshare (up to)	1 x 250W	2 x 250W	N/A	N/A	N/A	Communication	Mains Operating Voltage
Maximum totally output power, all channels driven	N/A	N/A	1500W	3000W	-	Standby power consumption	<1 W
Power Consumption	75W	150W	350W	700W	-	Networked standby power consumption	<6 W
Thermal Output	256 BTU	512 BTU	1200 BTU	2400 BTU	-		
Polarity (Default)	Non-inverting	Non-inverting	Non-inverting	Non-inverting	-		
Dimensions	44 x 220 x 325 mm (1 <sup>3/4</sup> x 8 <sup>11/16</sup> x 11 <sup>5/8"</sup> )	88 x 440 x 329 mm (3 <sup>4/8</sup> x 17 <sup>5/16</sup> x 12 <sup>15/16"</sup> )	88 x 440 x 329 mm (3 <sup>4/8</sup> x 17 <sup>5/16</sup> x 12 <sup>15/16"</sup> )	86.8 x 438 x 427 mm (3 <sup>3/16</sup> x 17 <sup>1/8</sup> x 16 <sup>13/16"</sup> )	86.8 x 438 x 427 mm (3 <sup>3/16</sup> x 17 <sup>1/8</sup> x 16 <sup>13/16"</sup> )		
Output Voltage	Universal Mains, 100V-240V, 50Hz-60Hz	80Vp / 160Vpp (SE unloaded), 160Vp / 320Vpp (BTL unloaded)	80Vp / 160Vpp (SE unloaded), 160Vp / 320Vpp (BTL unloaded)	80Vp / 160Vpp (SE unloaded), 160Vp / 320Vpp (BTL unloaded)	-100 dB (20 Hz – 20 kHz)		
Signal to noise-ratio	>106dB (A-weighted, 20Hz - 20kHz, 8 Ohm load)	>108dB (A-weighted, 20Hz – 20kHz, 8 Ohm load)	>108dB (A-weighted, 20Hz – 20kHz, 8 Ohm load)	>108dB (A-weighted, 20Hz – 20kHz, 8 Ohm load)	0.03% @ 1 W (N@1 kHz (@1W)		
THD+N (typical)	<0.05% (20Hz - 20kHz, 8Ohm load, 3dB below rated power)	<0.05% (20Hz – 20kHz, 8 Ohm load, 3dB below rated power)	<0.05% (20Hz – 20kHz, 8 Ohm load, 3dB below rated power)	<0.05% (20Hz – 20kHz, 8 Ohm load, 3dB below rated power)	5 Hz – 50 kHz (-3db)		
Frequency Response	+0/-0.25dB 20Hz - 20kHz (8 Ohm load, 3dB below rated power)	+0/-0.25dB 20Hz - 20kHz (8 Ohm load, 3dB below rated power)	+0/-0.25dB 20Hz - 20kHz (8 Ohm load, 3dB below rated power)	+0/-0.25dB 20Hz - 20kHz (8 Ohm load, 3dB below rated power)			
Protection Circuits	Short circuit, DC, Undervoltage, Temperature and Overload protection	Short circuit, DC, Undervoltage, Temperature and Overload protection	Short circuit, DC, Undervoltage, Temperature and Overload protection	Short circuit, DC, Undervoltage, Temperature and Overload protection	-		
Power Supply	Switch mode power supply with Power Factor Correction (PFC) and standby converter	Switch mode power supply with Power Factor Correction (PFC) and standby converter	Switch mode power supply with Power Factor Correction (PFC) and standby converter	Switch mode power supply with Power Factor Correction (PFC) and standby converter	-		
Operating Voltage/Frequency	Universal Mains, 100V-240V, 50Hz-60Hz	Universal Mains, 100V-240V, 50Hz-60Hz	Universal Mains, 100V-240V, 50Hz-60Hz	Universal Mains, 100V-240V, 50Hz-60Hz	100 -120 V @ 60 Hz, 220 – 240 V @ 50 Hz		
Standby Consumption	<0.5W	<0.5W	<0.5W	<0.5 W (green mode)			
Accessories	Rack Mount Kit, Wall/desktop mount kit (sold separately)	Rack mount kit (pre-installed)	Rack mount kit (pre-installed)	Rack mount kit			
Power Ratings	1% THD @ 120Vac and 230Vac	1% THD @ 120Vac and 230Vac	1% THD @ 120Vac and 230Vac	1% THD @ 120Vac and 230Vac	-		
Cabinet Finish	Black Anodised	Black Anodised	Black Anodised	Black Anodised			

Anthra Subwoofer Series

Model Name	Anthra W10	Anthra W12	Anthra W15
System Format	Active - Sealed Cabinet	Active - Sealed Cabinet	Active - Sealed Cabinet
Drive Unit Complement	1x 254 mm (10") High Linear-Excursion Triple Suspension Driver	1x 305 mm (12") High Linear-Excursion Triple Suspension Driver	1x 381 mm (15") High Linear-Excursion Triple Suspension Driver
Amplifier Classification	High-Efficiency Class-D	High-Efficiency Class-D	High-Efficiency Class-D
Lower Frequency Limit	-6dB @17Hz	-6dB @16Hz	-6dB @16Hz
Upper Frequency Limit	(LPF Off) -6dB @400Hz	(LPF Off) -6dB @400Hz	(LPF Off) -6dB @400Hz
Driver Excursion (pk-pk)	50 mm (1 <sup>5/8"</sup> )	50 mm (1 <sup>5/8"</sup> )	50 mm (1 <sup>5/8"</sup> )
DSP	28Bit 50MIPS Configurable through MaestroUnite	28Bit 50MIPS Configurable through MaestroUnite	28Bit 50MIPS Configurable through MaestroUnite
Analogue Digital Conversion	Autorangeing input which combines a 10Vrms maximum input with low signal to noise for small signals	Autorangeing input which combines a 10Vrms maximum input with low signal to noise for small signals	Autorangeing input which combines a 10Vrms maximum input with low signal to noise for small signals
Amplifier Output Power, 240Vac	Instantaneous: 500W*   Continuous short-term: 425W**	Instantaneous: 1700W*   Continuous short-term: 900W**	Instantaneous: 2500W*   Continuous short-term: 1400W**
Amplifier Output Power, 120Vac	Instantaneous: 450W   Continuous short-term: 390W	Instantaneous: 1325W   Continuous short-term: 700W	Instantaneous: 2500W   Continuous short-term: 1400W
LED UI Control	Brightness, On-Off	Brightness, On-Off	Brightness, On-Off
Phase Control	0-360 Degrees measured at LPF Crossover	0-360 Degrees measured at LPF Crossover	0-360 Degrees measured at LPF Crossover
Low Pass Filter	20-200Hz LPF with Roll off Adjustable from -3 to -48dB/Oct in 3dB/Oct steps	20-200Hz LPF with Roll off Adjustable from -3 to -48dB/Oct in 3dB/Oct steps	20-200Hz LPF with Roll off Adjustable from -3 to -48dB/Oct in 3dB/Oct steps
Custom EQ	Configurable through MaestroUnite;3 pre-defined EQ curves plus 3 custom EQ curves each with 8 band custom EQ supporting (Peaking, High Shelf, Low Shelf, High Pass)	Configurable through MaestroUnite;3 pre-defined EQ curves plus 3 custom EQ curves each with 8 band custom EQ supporting (Peaking, High Shelf, Low Shelf, High Pass)	Configurable through MaestroUnite;3 pre-defined EQ curves plus 3 custom EQ curves each with 8 band custom EQ supporting (Peaking, High Shelf, Low Shelf, High Pass)
Volume Level	Wide adjustable input gain to allow maximum output from a wide range of input signals	Wide adjustable input gain to allow maximum output from a wide range of input signals	Wide adjustable input gain to allow maximum output from a wide range of input signals
Inputs	Stereo Unbalanced RCA (or mono/LFE using only connector marked LFE)Mono/LFE Balanced XLR	Stereo Unbalanced RCA (or mono/LFE using only connector marked LFE)Mono/LFE Balanced XLR	Stereo Unbalanced RCA (or mono/LFE using only connector marked LFE)Mono/LFE Balanced XLR
Outputs	Stereo unbalanced outputs with unbuffered throughput from RCA InputsMono/LFE Balanced XLR outputs with unbuffered throughput from XLR Input	Stereo unbalanced outputs with unbuffered throughput from RCA InputsMono/LFE Balanced XLR outputs with unbuffered throughput from XLR Input	Stereo unbalanced outputs with unbuffered throughput from RCA InputsMono/LFE Balanced XLR outputs with unbuffered throughput from XLR Input
Mains Input Voltage	Universal Mains, 85-265VAC	Universal Mains, 85-265VAC	Universal Mains, 85-265VAC
External Dimensions (without feet) (H x W x D)	321 x 321 x 321 mm (12 <sup>5/8</sup> x 12 <sup>5/8</sup> x 12 <sup>5/8"</sup> )	374 x 374 x 374 mm (14 <sup>3/4</sup> x 14 <sup>3/4</sup> x 14 <sup>3/4"</sup> )	439 x 439 x 439 mm (17 <sup>5/16</sup> x 17 <sup>5/16</sup> x 17 <sup>5/16"</sup> )
Weight	20 kg (44 lb 1 oz)	28.6 kg (63 lb 1 oz)	35.4 kg (78 lb 1 oz)
Power consumption	120W	200W	550W
Cabinet Construction	Braced 18mm thick MDF with 36mm front baffle	Braced 25mm thick MDF with 36mm front baffle	Braced 25mm thick MDF with 36mm front baffle
Grille	Cloth covered magnetically attached Grilles	Cloth covered magnetically attached Grilles	Cloth covered magnetically attached Grilles

\* Maximum RMS output for an instantaneous signal \*\* Sinewave for 10 seconds

Basics

Application	In-Ceiling		In-Wall	
Model Name	C165	C180	W165	W180
Sensitivity (1w@1m)	88.5 dB	90 dB	88.5 dB	90 dB
Cutout Size	Ø 211 mm (8 <sup>1/4"</sup> )	Ø 247 mm (9 <sup>3/4"</sup> )	332 x 213 mm (13 <sup>1/8</sup> x 8 <sup>3/8"</sup> )	387 x 234 mm (15 <sup>1/4</sup> x 9 <sup>3/16"</sup> )
Mounting Depth	116 mm (4 <sup>5/8"</sup> )	122 mm (4 <sup>7/8"</sup> )	92 mm (3 <sup>5/8"</sup> )	100 mm (3 <sup>15/16"</sup> )
External Dimensions Inc Grilles (Ø x D) or (H x W x D)	Ø 250 x 120 mm (Ø 9 <sup>13/16</sup> x 4 <sup>3/4"</sup> )	Ø 285 x 126 mm (Ø 11 <sup>1/4</sup> x 4 <sup>5/8"</sup> )	Ø 285 x 96 mm (11 <sup>1/8</sup> x 3 <sup>3/4"</sup> )	441 x 288 x 104 mm (17 <sup>3/8</sup> x 11 <sup>5/16</sup> x 4 <sup>1/8"</sup> )
Recommended Amplifier Power	20 – 65 W	30 – 120 W	20 – 65 W	30 – 120 W
Continuous Power Handling (RMS)	65 W	120 W	65 W	120 W
Nominal Impedance	6 Ohms	6 Ohms	6 Ohms	6 Ohms
Drive Unit Complement	165 mm (6 <sup>1/2"</sup> ) MMP II mid-bass driver 25 mm (1") C-CAM tweeter	203 mm (8") MMP II mid-bass driver 25 mm (1") C-CAM tweeter	165 mm (6 <sup>1/2"</sup> ) MMP II mid-bass driver 25 mm (1") C-CAM tweeter	203 mm (8") MMP II mid-bass driver 25 mm (1") C-CAM tweeter
Frequency Response, Installed (-6dB)	60 Hz – 25 kHz	50 Hz – 25 kHz	60 Hz – 25 kHz	50 Hz – 25 kHz
Maximum Peak SPL	107.4 dBA	111.6 dBA	107.4 dBA	111.6 dBA
System Format	2-Way	2-Way	2-Way	2-Way
HF Switch	Yes	Yes	Yes	Yes
Construction Material	Mineral filled ABS plastic, RoHS2 Compliant	Mineral filled ABS plastic, RoHS2 Compliant	Mineral filled ABS plastic, RoHS2 Compliant	Mineral filled ABS plastic, RoHS2 Compliant
Weight	1.92 kg (4 lb 4 oz)	2.72 kg (6 lb)	2.21 kg (4 lb 14 oz)	3.08 kg (6 lb 12 oz)
Pre-Construction bracket	CM-B	CL-B	WB6	WB8
Back Box	CSM-BOX	CSM-BOX	-	WCBOX-L

Climate

Application	Wall Mounted			
Model Name	Climate 50	Climate 60	Climate 60-T2	Climate 80
Sensitivity (1W@1m)	87 dB	88 dB	88 dB	89.5 dB
External Dimensions Inc Grilles (H x W x D)	285 x 172.5 x 160 mm (11 <sup>1/4</sup> x 6 <sup>13/16</sup> x 6 <sup>5/16"</sup> )	325 x 185 x 180 mm (12 <sup>11/16</sup> x 7 <sup>5/16</sup> x 7 <sup>2/16"</sup> )	325 x 185 x 180 mm (12 <sup>11/16</sup> x 7 <sup>5/16</sup> x 7 <sup>2/16"</sup> )	405 x 230 x 221.5 mm (15 <sup>15/16</sup> x 9 <sup>1/16</sup> x 8 <sup>12/16"</sup> )
Overall Depth (With Bracket)	210.4 mm (8 <sup>5/16"</sup> )	235.4 mm (9 <sup>5/16"</sup> )	235.4 mm (9 <sup>5/16"</sup> )	273 mm (10 <sup>3/8"</sup> )
Recommended Amplifier Power	10 – 80 W	15 – 100 W	15 – 100 W	20 – 120 W
Continuous Power Handling (RMS)	80 W	100 W	2 x 50 W	120 W
Nominal Impedance	8 Ohms	8 Ohms	8 + 8 Ohms	8 Ohms
Drive Unit Complement	140 mm (5 <sup>1/2"</sup> ) C-CAM mid-bass driver 25mm (1") C-CAM tweeter	165 mm (6 <sup>1/2"</sup> ) C-CAM mid-bass driver 25mm (1") C-CAM tweeter	165 mm (6 <sup>1/2"</sup> ) C-CAM mid-bass driver 2 x 25mm (1") C-CAM tweeter	203 mm (8") C-CAM mid-bass driver 25mm (1") C-CAM tweeter
Frequency Response	75 Hz – 30 kHz	63 Hz – 30 kHz	63 Hz – 30 kHz	50 Hz – 30 kHz
Maximum SPL	106.8 dBA	108.8 dBA	108.8 dBA	111.1 dBA
Construction Material	High-density polypropylene enclosure / Aluminium grille	High-density polypropylene enclosure / Aluminium grille	High-density polypropylene enclosure / Aluminium grille	High-density polypropylene enclosure / Aluminium grille
Operating Temperature Range	-25° to 65° C -13° to 149° F	-25° to 65° C -13° to 149° F	-25° to 65° C -13° to 149° F	-25° to 65° C -13° to 149° F
IP Ratings	IP55	IP55	IP55	IP55
Weight	3.66 kg (8 lb 1 oz)	4.62 kg (10 lb 3 oz)	5.02 kg (11 lb 1 oz)	6.53 kg (14 lb 6 oz)

Climate Garden

Application	In-Ground / Mounted		Subwoofers	
Model Name	CLG140	CLG160	CLG-W10	CLG-W12
Sensitivity (1W@1m)	88 dB	89 dB	85 dB	87 dB
External Dimensions Inc Grilles (H x W) or (H x W x D)	130 x 175 mm (5 <sup>1/8</sup> x 6 <sup>7/8"</sup> )	190 x 220 mm (7 <sup>1/2</sup> x 8 <sup>11/16"</sup> )	340 mm x 434.5 mm (13 <sup>3/8</sup> x 17 <sup>18"</sup> )	750 x 380 x 576 mm (19 <sup>1/2</sup> x 14 <sup>15/16</sup> x 22 <sup>11/16"</sup> )
Recommended Amplifier Power	10 – 40 W per speaker	10 – 60 W per speaker	80 – 150 W R.M.S.	100 – 250 W
Continuous Power Handling (RMS)	40 W (Crossover set to minimum 100 Hz @ 12 dB/ Octave)	60 W (Crossover set to minimum 80 Hz @12 dB/ Octave)	150 W (IEC268-5)	250 W
Nominal Impedance	70/100 V line level	70/100 V line level	4 Ohms or 70/100 V line level (cable select)	4 Ohms or 70/100 V line level (cable select)
Drive Unit Complement	4" (102 mm) MMP II mid-bass driver 1" (25 mm) C-CAM tweeter	6" (152 mm) MMP II mid-bass driver 1" (25 mm) C-CAM tweeter	10" (254 mm) 'ICD' subwoofer C-CAM cone	12" (305 mm) 'ICD' subwoofer C-CAM cone
Frequency Response	100 Hz – 30 kHz	80 Hz – 30 kHz	35 Hz – 150 Hz	30 Hz – 100 Hz
Maximum SPL	104 dBA	107 dBA	105 dB @100Hz	110 dBA
Construction Material	Rigid, high impact cast polymer cabinet for long life and durability	Rigid, high impact cast polymer cabinet for long life and durability	Rotational moulded LDPE – Sealed cabinet	High impact moulded cabinet – robust and waterproof
Operating Temperature Range	-20° to 70° C -4° to 158° F	-20° to 70° C -4° to 158° F	-	-
IP Ratings	IP55	IP55	IP54	IP54
Weight	2.08 kg (4 lb 10 oz)	2.76 kg (6 lb 2 oz)	11.9 kg (26 lb 2 oz)	19.5 kg (42 lb 14 oz)
Mount	CLG-Mount / CLG-Spike R	CLG-Mount / CLG-Spike R	-	-

Cinergy

Application	In-Wall / On-Wall		In-Wall / Floorstanding	
Model Name	Cinergy 100	Cinergy 200	Cinergy 300	Cinergy Sub15
Sensitivity (2.83Vrms@1m)	84dB	90dB	90dB	86dB @ 100 Hz
External Dimensions Inc Grilles (H x W x D)	460 x 350 x 174.1 mm (18 <sup>1/8</sup> x 13 <sup>3/4</sup> x 6 <sup>7/8"</sup> )	904 x 300 x 173.6 mm (35 <sup>9/16</sup> x 11 <sup>13/16</sup> x 6 <sup>13/16"</sup> )	1080 x 300 x 253.6 mm (42 <sup>1/2</sup> x 11 <sup>13/16</sup> x 10")	540 x 540 x 280 mm (21 <sup>1/4</sup> x 21 <sup>1/4</sup> x 11")
Recommended Amplifier Power (RMS)	100 - 800 W (IA750-2 or IA750-4)	200 - 1400 W (IA750-2 or IA750-4)	200 - 1400 W (IA750-2 or IA750-4)	Must be used with IA750-2 / IA



Creator Series

Application	In-Ceiling							
Model Name	C1S	C1M	C1L	C2S	C2M	C2M-T2X	C2M-CP	
Sensitivity (2.83Vrms@1m, Installed)	84dB	86dB	88dB	84dB	86dB	86dB	87dB	
Cutout Size	Ø 171 mm (6 3/4")	Ø 212 mm (8 3/8")	Ø 248 mm (9 3/4")	Ø 171 mm (6 3/4")	Ø 212 mm (8 3/8")	Ø 212 mm (8 3/8")	Ø 212 mm (8 3/8")	
Mounting Depth	99 mm (3 7/8")	99 mm (3 7/8")	99 mm (3 7/8")	99 mm (3 7/8")	99 mm (3 7/8")	99 mm (3 7/8")	1775 mm (6 63/64")	
External Dimensions Inc Grilles (H x W x D)	Ø 201 x 103 mm (Ø 7 15/16 x 4 4/16")	Ø 242 x 103 mm (Ø 9 1/2 x 4 4/16")	Ø 278 x 103 mm (Ø 10 15/16 x 4 4/16")	Ø 201 x 103 mm (Ø 7 15/16 x 4 4/16")	Ø 242 x 103 mm (Ø 9 1/2 x 4 4/16")	Ø 242 x 103 mm (Ø 9 1/2 x 4 4/16")	Ø 242 x 181.5 mm (Ø 9 1/2 x 7 1/8")	
Recommended Amplifier Power (RMS into 8 Ohms, Music Signal)	25-100 W	35-130 W	40-150 W	35-130 W	40-150 W	40-150 W (Mono) 2 x 75 W (Stereo)	35-130 W	
Continuous Power Handling (RMS into Nominal Impedance, Pink Noise with 6dB Crest Factor)	50 W	65 W	75 W	65 W	75 W	150 W (Mono) 2 x 75 W (Stereo)	65 W	
Nominal Impedance	8 Ohms	8 Ohms	8 Ohms	8 Ohms	8 Ohms	4 Ohms (Mono) 8 Ohms (Stereo)	8 Ohms	
Minimum Impedance (20Hz to 20kHz)	6.6 Ohms @ 150 Hz	6.5 Ohms @ 150 Hz	6.4 Ohms @ 150 Hz	6.8 Ohms @ 150 Hz	6.6 Ohms @ 150 Hz	3.4 Ohms @ 15 kHz (Mono) 6.8 Ohms @ 15 kHz (Stereo)	6.4 Ohms @ 15 kHz	
Drive Unit Complement	5" (127 mm) C-CAM mid-bass driver 1" (25 mm) C-CAM tweeter	7" (178 mm) C-CAM mid-bass driver 1" (25 mm) C-CAM tweeter	9" (229 mm) C-CAM mid-bass driver 1 1/4" (32 mm) C-CAM tweeter	5" (127 mm) RST II mid-bass driver 1" (25 mm) C-CAM tweeter	7" (178 mm) RST II mid-bass driver 1" (25 mm) C-CAM tweeter	7" (178 mm) RST II dual-coil mid-bass driver 2 x 1" (25 mm) C-CAM tweeter	7" (178 mm) RST II mid-bass driver 1" (25 mm) C-CAM tweeter	
Frequency Response, Installed (-6dB)	40 Hz - 30 kHz	35 Hz - 30 kHz	30 Hz - 25 kHz	40 Hz - 30 kHz	35 Hz - 35 kHz	35 Hz - 30 kHz	70 Hz - 35 kHz	
Maximum Peak SPL* (single speaker @ 1m Z-Weighted)	110dB	113dB	116dB	111dB	114dB	(Mono) 114dB	116dB	
Channels	1	1	1	1	1	1 (Mono) 2 (Stereo)	1	
System Format	2-Way	2-Way	2-Way	2-Way	2-Way	2-Way	2-Way	
Bass Alignment	-	-	-	-	-	-	Sealed	
Crossover Frequency	LF/HF: 3 kHz	LF/HF: 2 kHz	LF/HF: 2 kHz	LF/HF: 2.5 kHz	LF/HF: 2.25 kHz	LF/HF: 2.25 kHz	LF/HF: 2.5 kHz	
Boundary Switch	-	-	-	On/Off	On/Off	On/Off	On/Off	
MF Switch	-	-	-	-	-	-	-	
HF Switch	-	-	-	-/0/+	-/0/+	-/0/+	-/0/+	
Music/Movie Switch	-	-	-	-	-	Music/Movie	-	
Mono/Stereo Switch	-	-	-	-	-	Mono/Stereo	-	
Construction Material	Mineral filled ABS plastic, RoHS2 Compliant	Mineral filled ABS plastic, RoHS2 Compliant	Mineral filled ABS plastic, RoHS2 Compliant	Mineral filled ABS plastic, RoHS2 Compliant	Mineral filled ABS plastic, RoHS2 Compliant	Mineral filled ABS plastic, RoHS2 Compliant	Mineral filled ABS plastic, RoHS2 Compliant	
Weight	1.4 kg (3 lb 1 oz)	1.9 kg (4 lb 3 oz)	2.5 kg (5 lb 8 oz)	1.5 kg (3 lb 5 oz)	2 kg (4 lb 6 oz)	2.1 kg (4 lb 10 oz)	2.6 kg (5 lb 11 oz)	
Pre-Construction bracket	CS-B	CM-B	CL-B	CS-B	CM-B	CM-B	CM-B	
Back Box	CSM-BOX	CSM-BOX	CML-BOX	CSM-BOX	CSM-BOX	CSM-BOX	CSM-BOX	

Application	In-Ceiling								
Model Name	C2L	C2L-T2X	C2L-CP	C3M	C3L	C3L-CP	C3L-A	CSS230	
Sensitivity (2.83Vrms@1m, Installed)	88dB	88dB	89dB	87dB	89dB	89dB	89dB	86dB (1W@1M)	
Cutout Size	Ø 248 mm (9 3/4")	Ø 248 mm (9 3/4")	Ø 248 mm (9 3/4")	Ø 212 mm (8 3/8")	Ø 248 mm (9 3/4")	Ø 248 mm (9 3/4")	Ø 248 mm (9 3/4")	Ø 211 mm (8 5/16")	
Mounting Depth	99 mm (3 7/8")	99 mm (3 7/8")	177.5 mm (6 63/64")	148 mm (5 13/16")	157 mm (6 3/16")	177.5 mm (6 63/64")	157 mm (6 3/16")	50 mm (1 15/16")	
External Dimensions Inc Grilles (H x W x D)	Ø 278 x 103 mm (Ø 10 15/16 x 4 4/16")	Ø 278 x 103 mm (Ø 10 15/16 x 4 4/16")	Ø 278 x 181 mm (Ø 10 15/16 x 7 1/8")	Ø 242 x 151 mm (Ø 9 1/2 x 5 15/16")	Ø 278 x 161 mm (Ø 10 15/16 x 6 3/16")	Ø 278 x 181 mm (Ø 10 15/16 x 7 1/8")	Ø 278 x 161 mm (Ø 10 15/16 x 6 3/16")	Ø 250 x 54 mm (Ø 9 15/16 x 2 1/8")	
Recommended Amplifier Power (RMS into 8 Ohms, Music Signal)	60-240 W	60-240 W (Mono) 2 x 60-240 W (Stereo)	50-200 W	45-180 W	60-225 W	45-180 W	60-225 W	10 - 60 W	
Continuous Power Handling (RMS into Nominal Impedance, Pink Noise with 6dB Crest Factor)	120 W	240 W (Mono) 2 x 120 W (Stereo)	100 W	120 W	150 W	120 W	150 W	40 W - Full range (60 W with crossover set to 100 Hz @ 12 dB/Octave)	
Nominal Impedance	8 Ohms	4 Ohms (Mono) 8 Ohms (Stereo)	8 Ohms	6 Ohms	6 Ohms	6 Ohms	6 Ohms	8 Ohms	
Minimum Impedance (20Hz to 20kHz)	6.4 Ohms @ 15 kHz	3.2 Ohms @ 15 kHz (Mono) 6.4 Ohms @ 15 kHz (Stereo)	6.6 Ohms @ 10 kHz	4.8 Ohms @ 2 kHz	4.8 Ohms @ 2 kHz	4.9 Ohms @ 2 kHz	4.6 Ohms @ 2 kHz	-	
Drive Unit Complement	9" (229 mm) RST II mid-bass driver 1 1/4" (32 mm) C-CAM tweeter	9" (229 mm) RST II dual-coil mid-bass driver 2 x 1 1/4" (32 mm) C-CAM tweeter	9" (229 mm) RST II mid-bass driver 1 1/4" (32 mm) C-CAM tweeter	7" (178 mm) RDT III bass driver 4" (102 mm) IDC II midrange driver 1" (25 mm) IDC II tweeter	9" (229 mm) RDT III bass driver 4" (102 mm) IDC II midrange driver 1" (25 mm) IDC II tweeter	9" (229 mm) RDT III bass driver 4" (102 mm) IDC II midrange driver 1" (25 mm) IDC II tweeter	9" (229 mm) RDT III bass driver 4" (102 mm) IDC II midrange driver 1" (25 mm) IDC II tweeter	3 x 3" (76 mm) C-CAM mid-bass drivers 3" (76 mm) C-CAM tweeter	
Frequency Response, Installed (-6dB)	30 Hz - 25 kHz	30 Hz - 30 kHz	75 Hz - 25 kHz	45 Hz - 35 kHz	45 Hz - 35 kHz	80 Hz - 35 kHz	45 Hz - 35 kHz	100 Hz - 30 kHz sealed CP* (85 Hz - 30 kHz - open back)	
Maximum Peak SPL* (single speaker @ 1m Z-Weighted)	117dB	(Mono) 117dB	120dB	116dB	119dB	122dB	119dB	103.8 dBA	
Channels	1	1 (Mono) 2 (Stereo)	1	1	1	1	1	1	
System Format	2-Way	2-Way	2-Way	3-Way	3-Way	3-Way	3-Way	2-Way	
Bass Alignment	-	-	Sealed	-	-	Sealed	-	Sealed	
Boundary Switch	On/Off	On/Off	On/Off	On/Off	On/Off	On/Off	On/Off	-	
MF Switch	-	-	-	-/0/+	-/0/+	-/0/+	-/0/+	-	
HF Switch	-/0/+	-/0/+	-/0/+	-/0/+	-/0/+	-/0/+	-/0/+	-	
Music/Movie Switch	-	Music/Movie	-	-	-	-	-	-	
Mono/Stereo Switch	-	Mono/Stereo	-	-	-	-	-	-	
Construction Material	Mineral filled ABS plastic, RoHS2 Compliant	Mineral filled ABS plastic, RoHS2 Compliant	Mineral filled ABS plastic, RoHS2 Compliant	Mineral filled ABS plastic, RoHS2 Compliant	Mineral filled ABS plastic, RoHS2 Compliant	Mineral filled ABS plastic, RoHS2 Compliant	Mineral filled ABS plastic, RoHS2 Compliant	Mineral filled ABS plastic, RoHS2 Compliant	
Weight	2.5 kg (5 lb 8 oz)	2.7 kg (6 lb)	3.3 kg (7 lb 5 oz)	3.4 kg (7 lb 8 oz)	5 kg (11 lb)	5.7 kg (12 lb 10 oz)	5.6 kg (12 lb 5 oz)	2.88 kg (6 lb 5 oz)	
Pre-Construction bracket	CL-B	CL-B	CL-B	CM-B	CL-B	CL-B	CL-B	CM-B	
Back Box	CML-BOX	CML-BOX	CML-BOX	CSM-BOX	CML-BOX	CML-BOX	CML-BOX	CSM-BOX	

Application	In-Wall							
Model Name	WSS130	WSS230	WSS430	W1M-E	W1M	W2M	W2M-CP	
Sensitivity (2.83Vrms@1m, Installed)	87dB (1W@1M)	87dB (1W@1M)	87dB (1W@1M)	84dB	87dB	87dB	87dB	
Cutout Size	346 x 101 mm (13 5/8 x 3 3/32")	346 x 101 mm (13 5/8 x 3 3/32")	346 x 101 mm (13 5/8 x 3 3/32")	527 x 198 mm (20 3/4 x 7 13/16")	527 x 198 mm (20 3/4 x 7 13/16")	527 x 198 mm (20 3/4 x 7 13/16")	527 x 199 mm (20 3/4 x 7 13/16")	
Mounting Depth	50 mm (1 15/16")	50 mm (1 15/16")	50 mm (1 15/16")	85 mm (3 3/8")	85 mm (3 3/8")	85 mm (3 3/8")	97 mm (3 13/16")	
External Dimensions Inc Grilles (H x W x D)	385 x 140.5 x 54.25 mm (15 x 5 1/2 x 2 1/8")	385 x 140.5 x 54.25 mm (15 x 5 1/2 x 2 1/8")	385 x 140.5 x 54.25 mm (15 x 5 1/2 x 2 1/8")	560 x 231 x 90 mm (22 1/16 x 9 1/8 x 3 9/16")	560 x 231 x 90 mm (22 1/16 x 9 1/8 x 3 9/16")	560 x 231 x 90 mm (22 1/16 x 9 1/8 x 3 9/16")	560 x 231 x 102 mm (22 1/16 x 9 1/8 x 4 1/16")	
Recommended Amplifier Power (RMS into 8 Ohms, Music Signal)	10 - 100 W	10 - 100 W	10 - 120 W	25-100 W	30-110 W	45-180 W	40-150 W	
Continuous Power Handling (RMS into Nominal Impedance, Pink Noise with 6dB Crest Factor)	60 W - Full range (100 W with crossover set to 100 Hz @ 12 dB/Octave)	60 W Full range (100 W with crossover set to 100 Hz @ 12 dB/Octave)	75 W Full range (120 W with crossover set to 100 Hz @ 12 dB/Octave)	50 W	75 W	120 W	100 W	
Nominal Impedance	8 Ohms	8 Ohms	8 Ohms	8 Ohms	6 Ohms	6 Ohms	6 Ohms	
Minimum Impedance (20Hz to 20kHz)	-	-	-	6.5 Ohms @ 200 Hz (6.2 Ohms @ 20 kHz)	4.8 Ohms @ 15 kHz	4.8 Ohms @ 15 kHz	4.8 Ohms @ 1 kHz (4.1 Ohms @ 15 kHz)	
Drive Unit Complement	3 x 3" (76 mm) MPD II mid-bass drivers 1" (25 mm) C-CAM tweeter	3 x 3" (76 mm) C-CAM mid-bass drivers 1" (25 mm) C-CAM tweeter	3 x 3" (76 mm) C-CAM mid-bass drivers MPD High frequency transducer	5" (127 mm) C-CAM mid-bass driver 1" (25 mm) C-CAM tweeter	2 x 5" (127 mm) C-CAM mid-bass driver 3" (76 mm) RST II midrange driver 1" (25 mm) C-CAM tweeter	2 x 5" (127 mm) RST II bass driver 3" (76 mm) RST II midrange driver 1" (25 mm) C-CAM tweeter	2 x 5" (127 mm) RST II bass driver 3" (76 mm) RST II midrange driver 1" (25 mm) C-CAM tweeter	
Frequency Response, Installed (-6dB)	75 Hz - 30 kHz	75 Hz - 30 kHz	70 Hz - 50 kHz	40 Hz - 30 kHz	40 Hz - 30 kHz	40 Hz - 35 kHz	60 Hz - 35 kHz	
Maximum Peak SPL* (single speaker @ 1m Z-Weighted)	105.6 dBA	105.6 dBA	106.5 dBA	110dB	113dB	116dB	118dB	
Channels	1	1	1	1	1	1	1	
System Format	2-Way	2-Way	2-Way	2-Way	2-Way	3-Way	3-Way	
Bass Alignment	-	-	-	N/A	N/A	N/A	Sealed	
Crossover Frequency	-	-	-	LF/HF: 2.5 kHz	LF/HF: 2.75 kHz	LF/HF: 650 kHz MF/HF: 3 kHz	LF/HF: 550 kHz MF/HF: 3 kHz	
Boundary Switch	-	-	-	N/A	N/A	On/Off	On/Off	
MF Switch	-	-	-	N/A	N/A	N/A	N/A	
HF Switch	-	-	-	N/A	N/A	-/0/+	-/0/+	
Construction Material	Mineral filled ABS plastic, RoHS2 Compliant	Mineral filled ABS plastic, RoHS2 Compliant	Mineral filled ABS plastic, RoHS2 Compliant	Mineral filled ABS plastic, RoHS2 Compliant	Mineral filled ABS plastic, RoHS2 Compliant	Mineral filled ABS plastic, RoHS2 Compliant	Mineral filled ABS plastic, RoHS2 Compliant	
Weight	1.4 kg (3 lb 2 oz)	1.4 kg (3 lb 2 oz)	1.1 kg (2 lb 6 oz)	2.6 kg (5 lb 11 oz)	3.4 kg (7 lb 8 oz)	3.9 kg (8 lb 9 oz)	4.4 kg (9 lb 11 oz)	
Pre-Construction bracket	WB3	WB3	WB3	WM-B	WM-B	WM-B	WM-B	
Back Box	-	-	-	WM-BOX	WM-BOX	WM-BOX	WM-BOX	

Application	In-Wall		
Model Name	W3M	CP-IW260X	CP-IW460X
Sensitivity (2.83Vrms@1m, Installed)	88dB	89dB (1W@1M)	89dB (1W@1M)
Cutout Size	527 x 198 mm (20 3/4 x 7 13/16")	880 x 230 mm (34 5/8 x 9 1/8")	880 x 230 mm (34 5/8 x 9 1/8")
Mounting Depth	85 mm (3 3/8")	96 mm (3 3/4")	96 mm (3 3/4")
External Dimensions Inc Grilles (H x W x D)	560 x 231 x 90 mm (22 1/16 x 9 1/8 x 3 9/16")	907 x 257 x 102 mm (35 3/4 x 10 1/8 x 4")	907 x 257 x 102 mm (35 3/4 x 10 1/8 x 4")
Recommended Amplifier Power (RMS into 8 Ohms, Music Signal)	60-225 W	60 - 150 W	60 - 150 W
Continuous Power Handling (RMS into Nominal Impedance, Pink Noise with 6dB Crest Factor)	150 W	150 W	150 W
Nominal Impedance	6 Ohms	6 Ohms	6 Ohms
Minimum Impedance (20Hz to 20kHz)	4.8 Ohms @ 150 Hz	-	-
Drive Unit Complement	2 x 5" (127 mm) RDT III bass driver 3" (76 mm) C-CAM midrange driver MPD tweeter	2 x 6 1/2" (165 mm) C-CAM bass drivers 2 x 4" (102 mm) C-CAM midrange drivers 1" (25 mm) C-CAM tweeter	2 x 6 1/2" (165 mm) RST C-CAM bass drivers 2 x 4" (102 mm) RST C-CAM mid-range drivers C-CAM H.F ribbon transducer
Frequency Response, Installed (-6dB)	45 Hz - 60 kHz	50 Hz - 30 kHz	50 Hz - 60 kHz
Maximum Peak SPL* (single speaker @ 1m Z-Weighted)	122dB	113.8 dBA	113.8 dBA
Channels	1	1	1
System Format	3-Way	3-Way	3-Way
Bass Alignment	N/A	Sealed	Sealed
Crossover Frequency	LF/HF: 650 kHz MF/HF: 3.5 kHz	L.F. - 500 Hz @ 12 dB/Octave M.F. - 500 Hz @ 12 dB/Octave 3 kHz @ 18 dB/Octave H.F. - 3 kHz @ 18 dB/Octave	L.F. - 500 Hz @ 12 dB/Octave M.F. - 500 Hz @ 12 dB/Octave 3 kHz @ 18 dB/Octave H.F. - 3 kHz @ 18 dB/Octave
Boundary Switch	On/Off	-	-
MF Switch	-/0/+	-	-
HF Switch	-/0/+	-	-
Construction Material	Mineral filled ABS plastic, RoHS2 Compliant	Cast Polymer enclosure, RoHS2 Compliant	Cast Polymer enclosure with die-cast Aluminium baffle, RoHS2 Compliant
Weight	4.7 kg (10 lb 6 oz)	11.98 kg (26 lb 6 oz)	12.98 kg (28 lb 6 oz)
Pre-Construction bracket	WM-B	WB12	WB12
Back Box	WM-BOX	-	-



## Custom Subwoofers

Application	In-Ceiling	In-Wall	Rack Mounted / Free Standing
Model Name	ICS-8	IWS-10	IWA-250 Amplifier
Sensitivity (1W@1m)	85 dB	86 dB	-
Cutout Size (Ø) or (H x W)	Ø 120 mm (Ø 4 3/4")	280 x 280 mm (11 x 11")	-
Mounting Depth	-	90 mm (3 1/2")	-
External Dimensions Inc Grilles (H x W x D)	235 x 280 x 396 mm (9 1/4 x 11 x 15 9/16")	314.21 x 314.21 x 101 mm (12 3/8 x 12 3/8 x 3 15/16")	43.7 x 432 x 263 mm (1 3/4 x 17 x 10 3/16")
Recommended Amplifier Power	150 W	150 W	-
Continuous Power Handling (RMS)	150 W - Full range - IEC268-5 rating	150 W	-
Nominal Impedance	8 Ohms	8 Ohms	-
Drive Unit Complement	8" (203 mm) C-CAM driver	10" (254 mm) C-CAM RDT driver	-
Frequency Response	40 Hz - 120 Hz	28 Hz - 120 Hz	25Hz - 120 Hz
Maximum SPL	107 dB	Single unit 109.8 dB / Pair 115.8 dB	-
Amplifier Power Output	-	-	250 W @ <1% THD+N
Amplifier Classification	-	-	Class D amplifier with switch mode power supply (SMPSU)
Construction Material	15 mm MDF construction, vinyl laminate surface	Mineral Filled ABS Plastic (RoHS Compliant)	3 mm thick fabricated steel case, moulded ABS front trim panel
Weight	10.2 kg (22 lb 8 oz)	3.8 kg (8 lb 6 oz)	4 kg (8 lb 12 oz)
Brackets	Flush Fit - CFB3-R (round) / CFB3-SQ (square). Pre-construction bracket included in above kits	-	-
Back Box	-	IWB-10 (In-Wall Back Box)	-

## Soundbars

Application	Passive / Free Standing		
Model Name	SB-2	SB-3	SB-4
Sensitivity (1W@1m)	84 dB	Left and Right Channels: 84 dB Centre Channel: 87 dB	87 dB
Overall Depth (With Grille)	93 mm (3 11/16")	93 mm (3 11/16")	92 mm (3 5/8")
External Dimensions Inc Grilles (H x W x D)	147 x 1107 x 93 mm (5 13/16 x 43 9/16 x 3 11/16")	147 x 1307 x 93 mm (5 13/16 x 51 7/16 x 3 11/16")	147 x 1562 x 92 mm (5 3/4 x 61 1/2 x 3 5/8")
Recommended Amplifier Power	30 - 100 W	30 - 100 W	30 - 100 W
Continuous Power Handling (RMS)	40 W	Left and Right Channels: 40 W Centre Channel: 80 W	80 W
Nominal Impedance	8 Ohms	8 Ohms	8 Ohms
Drive Unit Complement	3 x 4" (102 mm) C-CAM mid-bass drivers 3 x 1" (25 mm) C-CAM tweeters 3 x ABRs	4 x 4" (102 mm) C-CAM mid-bass drivers 3 x 1" (25 mm) C-CAM tweeters 4 x ABRs	6 x 4" (102 mm) C-CAM mid-bass drivers 3 x 1" (25 mm) C-CAM tweeters 4 x ABRs
Frequency Response	90 Hz - 30 kHz	80 Hz - 30 kHz	70 Hz - 30 kHz
Maximum SPL	104 dBA (108.8 dBA all channels driven)	104 dBA (108.8 dBA all channels driven)	104 dBA (108.8 dBA all channels driven)
Construction Material	MDF	MDF	MDF
Weight	7.64 kg (16 lb 12 oz)	91 kg (20 lb)	12 kg (26 lb 7 oz)
Suitable for display sizes	50" - 60"	60"+	70"+
On-Wall Bracket	BSB	BSB	BSB

## Specialist

Application	In-Ceiling	In-Wall	In-Ceiling
Model Name	CF230	IV140	CPC120
Sensitivity (1W@1m)	82.5 dB	82 dB (when installed as directed)	85 dB
Cut Out Size (Ø or H x W)	Flush Fit Ø 120 mm (4 3/4") / Retrofit Ø 90 mm (3 5/8")	591 x 350.5 mm (23 1/4 x 13 13/16")	Ø 65 mm (2 1/2")
Mounting Depth	81.5 mm (3 19/32")	94 mm (3 11/16")	91.5 mm (3 5/8")
External Dimensions Inc Grilles (Ø x D) or (H x W x D)	Ø 112 x 83.62 mm (Ø 4 7/16" x 3 5/16")	642 x 401.5 x 106 mm (25 1/4" x 15 13/16" x 4 3/16")	Ø 80 x 96 mm (Ø 3 1/8" x 3 3/4")
Power Handling (RMS)	30 W - Full range - IEC268-5 rating 100 W - Music program (Using High Pass crossover filter @120 Hz)	50 W - Full range - IEC268-5 rating 100 W - Music program (Using Minimum 80 Hz High Pass filter)	20 W 50 W (using crossover)
Impedance	8 Ohms	8 Ohms	8 Ohms
Driver Size & Technology	3 1/2" (89 mm) mid-bass C-CAM driver 3/4" (19 mm) C-CAM Gold Dome tweeter	1 x LF transducer 2 x HF transducers	2" (51 mm) Full range micro-driver
Frequency Response	100 Hz - 25 kHz	75 Hz - 18 kHz (CP sealed) 55 Hz - 18 kHz (Open back)	100 Hz - 20 kHz
Maximum SPL	98 dBA (Each - Full range) 103.3 dBA (Each - Using crossover)	102.8 dBA	101.9 dBA
Recommended Amp Requirements	10 - 30 W (Full range) 10 - 100 W (Using High Pass crossover filter @120 Hz)	20 - 50 W (Full range) 20 - 100 W (Using Minimum 80 Hz High Pass filter)	5 - 20 W 5 - 50 W (using crossover)
Construction Material	Mineral filled ABS plastic, RoHS2 Compliant	MDF	Steel Bezel Aluminium Enclosure
Weight	0.44 kg (1 lb)	9 kg (20 lb)	0.19 kg (0.42 lb)
Pre-Construction Bracket	Flush Fit - CFB3-R (round) / CFB3-SQ (square). Pre-construction bracket included in above kits Retrofit - CFB3-KIT	WBIV140	N/A

## Platinum

Application	In-Ceiling	In-Wall
Model Name	PLIC II	Platinum In-Wall 3G
Sensitivity (1W@1m)	90 dB	88 dB
Cutout Size (Ø) or (H x W)	Ø 273 mm (Ø 10 3/8")	1175 x 300 mm (46 1/4 x 11 13/16")
Mounting Depth	185 mm (7 5/16")	97.5 mm (3 15/16")
External Dimensions Inc Grilles (ØxD) or (H x W x D)	Ø 309 x 191.5 mm (Ø 12 3/16 x 7 1/2")	1207 x 332 x 105.5 mm (47 9/16 x 13 1/8 x 4 1/8")
Recommended Amplifier Power	50 - 150 W	150 - 600 W
Continuous Power Handling (RMS)	150 W	300 W
Nominal Impedance	4 Ohms (3.1 Ohms minimum @ 1.1 kHz)	4 Ohms
Drive Unit Complement	8" (203 mm) RDT II bass driver 2 x 2" (51 mm) C-CAM mid-range drivers MPD HF transducer	2 x 6" (152 mm) RDT III bass drivers 4" (102 mm) RDT II mid-range driver MPD III tweeter
Frequency Response	45 Hz - 60 kHz	27 Hz - >60 kHz
Maximum SPL	112 dBA	N/A
HF Level Switch (+1dB/OdB/-1dB)	Yes	Yes
MF Level Switch (+1dB/OdB/-1dB)	Yes	Yes
Construction Material	Mineral filled ABS plastic, RoHS2 Compliant, Die cast Aluminium	25 mm MDF with steel back
Weight	5.3 kg (11 lb 10 oz)	27.7 kg (61 lb)
Pre-Construction Bracket	CB10	N/A
Back Box	PLIC-BOX II or a bespoke sealed enclosure of 24 L	N/A

## SoundFrame

Application	In-Wall			On-Wall		
Model Name	SoundFrame 1	SoundFrame 2	SoundFrame 3	SoundFrame 1	SoundFrame 2	SoundFrame 3
Sensitivity (1W@1m)	86 dB	86 dB	85dB	86 dB	86 dB	85 dB
Cut Out Dimensions (H x W)	501 x 351mm (19 11/16 x 13 3/4")	751 x 201 mm (29 1/2 x 7 7/8")	251 x 251 mm (9 7/8 x 9 7/8")	-	-	-
Mounting Depth	75 mm (2 15/16")	75 mm (2 15/16")	59.5 mm (2 3/8")	-	-	-
External Dimensions Inc Grilles (H x W x D)	552 x 402 x 88.25 mm (21 3/4 x 15 7/16 x 3 1/2")	802.5 x 252.5 x 87.5 mm (31 5/8 x 9 15/16 x 3 3/8")	301.5 x 301.5 x 77.5 mm (11 7/8 x 11 7/8 x 3")	540 x 390 x 87.5 mm (21 1/4 x 15 3/8 x 3 3/8")	790 x 240 x 87.5 mm (31 1/8 x 9 3/16 x 3 3/8")	289 x 289 x 77.5 mm (11 3/8 x 11 3/8 x 3")
Recommended Amplifier Power	20 - 100 W	20 - 100 W	20 - 50 W	20 - 100 W	20 - 100 W	20 - 50 W
Power Handling (RMS)	100 W	100 W	50 W	100 W	100 W	50 W
Nominal Impedance	8 Ohms	8 Ohms	8 Ohms	8 Ohms	8 Ohms	8 Ohms
Drive Unit Complement	6 1/2" (165 mm) C-CAM RST bass driver 4" (102 mm) C-CAM IDC mid-range driver 1" (25 mm) C-CAM tweeter	6 1/2" (165 mm) C-CAM RST bass driver 4" (102 mm) C-CAM IDC mid-range driver 1" (25 mm) C-CAM tweeter	4" (102 mm) MMP II mid-bass driver 1" (25 mm) C-CAM tweeter	6 1/2" (165 mm) C-CAM RST bass driver 4" (102 mm) C-CAM IDC mid-range driver 1" (25 mm) C-CAM tweeter	6 1/2" (165 mm) C-CAM RST bass driver 4" (102 mm) C-CAM IDC mid-range driver 1" (25 mm) C-CAM tweeter	4" (102 mm) MMP II mid-bass driver 1" (25 mm) C-CAM tweeter
Frequency Response	55 Hz - 35 kHz	55 Hz - 35 kHz	75 Hz - 35 kHz	55 Hz - 35 kHz	55 Hz - 35 kHz	75 Hz - 35 kHz
Maximum SPL	106 dBA	106 dBA	102.5 dBA	106 dBA	106 dBA	102.5 dBA
Construction Material	MDF	MDF	MDF	MDF	MDF	MDF
Weight	7.53 kg (16 lb 10 oz)	7.26 kg (16 lb)	3 kg (6 lb 10 oz)	7.44 kg (16 lb 6 oz)	7.06 kg (15 lb 9 oz)	2.76 kg (6 lb)

## Vecta

Application	Wall / Corner / Cluster Mounted	
Model Name	V240	V240-LV
Sensitivity (1W@1m)	88 dB	88 dB
External Dimensions Inc Grilles (H x W x D)	335.9 x 243.2 x 150 mm (13 1/4 x 9 9/16 x 5 7/8")	335.9 x 243.2 x 150 mm (13 1/4 x 9 9/16 x 5 7/8")
Overall Depth (With Bracket)	175.4 mm (6 7/8")	175.4 mm (6 7/8")
Recommended Amplifier Power	25 - 100 W	25 - 100 W
Power Handling (RMS)	100 W	100 W
Nominal Impedance	4 Ohms	70/100 V line level
Switch	-	70 V (2, 4, 8, 16, 32) power level
Drive Unit Complement	2 x 4" (102 mm) C-CAM mid-bass drivers 1" (25 mm) C-CAM tweeter	2 x 4" (102 mm) C-CAM mid-bass drivers 1" (25 mm) C-CAM tweeter
Frequency Response	70 Hz - 25 kHz	70 Hz - 25 kHz
Maximum SPL	108 dBA (each)	108 dBA (each)
Construction Material	Mineral filled ABS plastic, RoHS2 Compliant	Mineral filled ABS plastic, RoHS2 Compliant
Operating Temperature Range	-25° to 65° C -13° to 149° F	-25° to 65° C -13° to 149° F
IP Ratings	IP55	IP55
Brackets	V-Mount / V-Corner	V-Mount / V-Corner / V-Cluster
Weight	2.55 kg (5 lb 10 oz)	3.56 kg (7 lb 14 oz)

# Find out more about Monitor Audio Architectural Speakers



Visit

monitораudio.com for product information, to find your local specialist and to sign up for our newsletter.



Download

our Insider Magazine from our website to see the latest Monitor Audio installs from around the world.



Share

your custom installation with us on Facebook, Twitter and Instagram.  
@monitораudio #monitораudio



CEDIA MEMBER

Monitor Audio Ltd.  
24 Brook Road  
Rayleigh, Essex  
SS6 7XJ  
England  
Tel: +44 (0)1268 740580  
Email: [info@monitoraudio.group](mailto:info@monitoraudio.group)

[monitoraudio.com](https://www.monitoraudio.com)

Listen Again.