

Installation Guide

Plaster-Over Invisible Loudspeakers

(Panel loudspeaker with separate Backbox or Mounting Blocks)



Mobius 7



Mobius 5



iQ3

aminer®
THE INVISIBLE SPEAKER CO.

Contents

Caution: Read before installing this product ...1	Testing33
Environmental..... 3	Testing the speaker33
Sound in your Home:..... 4	Resistance test33
Sound in your Work or Leisure Environment: 4	Connect the APU protection device33
Message from the Managing Director5	Sweep test33
About the Manufacturer5	Music test33
Interactive PDF guide 6	Problems during test33
Introduction7	Problems during test.....34
Installation options7	Insecure drywall34
Unpacking7	Metal studs34
Packaging7	Cable buzzing34
Overview7	Lighting fixtures.....34
Setup tips..... 9	Finishing35
Installation 11	Filling the perimeter35
Mounting accessories11	Taping the joints and panel surface35
Speaker protectors12	Plastering options.....36
Cavity wall or solid wall installation.....14	Full plaster skim coat37
Installation (cavity walls).....15	Patch plaster38
Correct fixing method for BackboxCV15	Feather skim.....39
Shims.....18	Decorating.....40
Shim sizes18	Maintenance and cleaning.....40
Fixing shims to the speaker18	Accessories.....41
Fixing shims to the BackboxCV18	Subwoofers41
Cavity wall alignment options19	Troubleshooting.....42
Alignment and preparation 20	Advice for testing.....42
For new stud walls / ceilings using	No or low sound output42
BackboxCV 20	Distortion, buzzing or rattles at modest
Retrofit / pre-skimmed plasterboard	volumes.....43
(full wet skim finish).....21	Very low output after speaker passes
Retrofit / pre-skimmed plasterboard	electrical tests43
(patch plastered finish)22	Distortion at higher volume levels43
Retrofit / pre-skimmed plasterboard	Specifications 44
(feathered skim finish)23	Mobius series - Plaster over products 44
Retrofit or new drywall.....24	iQ series - Plaster over products..... 44
For new stud walls / ceilings using	Fire resisting installation.....45
Fixing Blocks25	Warranty information.....45
Fixing the speaker26	Copyright information45
Connecting the speaker26	Contact information 46
Installation (solid walls).....27	
Create aperture in brickwork/ concrete...27	
Create channel for cable27	
Solid wall alignment options28	
New build/New solid walls cutaway	
(Full wet skim finish).....29	
Retrofit / pre-skimmed solid wall	
cutaway (Patch plaster finish) 30	
Retrofit / pre-skimmed solid wall	
cutaway (Feathered plaster finish)31	
Connecting the speaker32	
Fixing the speaker32	

Caution: Read before installing this product



WARNING:

No attempt should be made to install this product within existing building structures unless you are certain that no electric cables, water pipes, gas pipes or supporting joists will be cut through.



FIRE PROTECTION:

When making an intrusion into an internal wall or ceiling to install an Amina loudspeaker be sure to check the appropriate regulations pertaining to the required fire rating. Depending on the location of the intrusion and the applicable regulations it may be necessary to build in or install additional fire rated components or products to enclose the speaker and back box. Amina Technologies take no responsibility for the correct specification and installation of any such fire protection system that is required behind their loudspeakers.



SPEAKER PROTECTION:

Amina loudspeakers should be installed with an APU or other suitable electrical overload protection device. These devices help ensure the loudspeaker operates reliably for many, many years ahead, by limiting and protecting against temporary excessive audio signals that could damage the product.

Common sense should always prevail though. Your product should never be operated at repeated or consistently excessive audio levels. Never operate your Amina speakers at a level where audio reproduction appears distorted.

For the ultimate in protection, Amina recommend using the Amina A100Q digital amplifier to drive your loudspeakers. It prevents unwanted and excessive electrical energy from reaching the speaker whilst allowing it to perform at its very best at all times.



METAL FRAME CEILINGS:

When installing in metal frame (MF) ceilings (& walls), please ensure the assembled metal frame is fully solid and secure and that all metal mating joints are mechanically fixed or bonded together. Metal joints that are not tightly fixed have the potential to generate spurious buzzing noises as the two free edges rub against each other when activated by the acoustic energy generated by the Amina Loudspeaker. All debris, loose screws, excess materials etc, should be removed from above the ceiling to avoid unwanted rattles.



CLEANLINESS DURING INSTALLATION:

Always install the speaker when the general environment is clean and dust free. Keep each speaker protected in its shipping carton until cutting work is complete and the installation room has been cleaned down thoroughly. Never expose the rear of the loudspeaker to an environment containing airborne metallic particles and dust, as these will be attracted to the speaker's high power magnet causing damage to the loudspeaker.

Caution: Read before installing this product

- To ensure optimal performance, please read this guide carefully and keep in a safe place for future reference.
- Install this product in a cool, dry, clean place - away from direct sunlight, cold bridges and heat sources, strong vibrational forces, chemical fumes, dust and moisture (steam).
- Do not expose this product to sudden temperature changes or locate it in an environment with high humidity. This is to prevent condensation forming inside which may cause damage to the product.
- Do not clean this product with chemical solvents as this may damage the finish. Use a clean, dry or damp cloth.
- Ensure that all installation mounting surfaces are able to support the weight of the product and any mounting accessories.
- After installation, avoid pushing on the wall or ceiling surface immediately in front of the speaker. Excessive excursion can crack the plaster around its perimeter and can damage the loudspeaker.
- Do not attempt to modify or repair the product. Contact your distributor or Amina if a fault should occur.
- The rear of the product should not be subject to chemical cleaning and should not be painted in any way.
- When plastering over, ensure only 2mm of material covers the product. More than this will degrade the performance of the product and could lead to product failure.
- Avoid the use of silicone sealants within the area of the loudspeaker. Sublimation of silicone will deposit a thin layer of silicone material on the panel surface, severely degrading the ability of plaster to bond to its surface.
- Prior to plastering, wipe the front panel surface clean with a damp cloth.

Environmental

- Before installing, ensure that the building is environmentally sealed, dehumidified to a maximum of RH50%, and at a stable temperature of at least 16 degrees centigrade (61 degrees Fahrenheit)
- This product should not be used with single thick coat plaster solutions or with other finishing methods that take days (rather than hours) to dry out.
- Please be aware that when this product is directly fitted into a solid brick, block or concrete wall structure (e.g. when using the solid wall backbox) vibrational energy is inevitably transferred into the solid wall structure. This energy can travel for some considerable distance up, down and along the structure. It is therefore recommended the product be fitted within acoustically isolated stud walls or ceiling sections where possible. The use of the product directly embedded in solid walls is not recommended in multi occupancy buildings.
- Please be aware that when this product is fitted in simple (stud or rafter with plasterboard/floorboard attached on either side) stud walls or wooden rafter ceiling/floor structures, vibrational energy is inevitably transferred into the building structure. This energy can travel for some considerable distance up, down and along the structure. It is therefore recommended the product be fitted within acoustically isolated stud walls or ceiling sections where possible. Special care should be taken when installing the product in multi occupancy buildings.
- Completed and fully dried plaster surfaces should be finished with permeable coatings / materials, to allow moisture in that coating or the adhesives used to apply those materials, to dry into the environment, rather than trap moisture in the speaker.
- During installation take care to use appropriate and suitable joint filling compounds to fill the gap between speaker and the surrounding surface. This gap should be no less than 2mm and no more than 5mm in width. Inappropriate compounds used in such a joint can shrink and crack excessively and lose strength. Allow the joint to dry thoroughly before applying surface skim coats, as shrinking in the joint depth whilst drying could create a very slight embossed outline in the finished and decorated surface.
- As a general rule in the construction industry, any drying process should be gradual rather than forced with excessive heat otherwise materials can lose strength and can crack.
- Amina Technologies take no responsibility for inappropriate use of materials and environmental conditions under which they are applied.

Sound in your Home:

Amina products are widely applied in whole house audio systems and multichannel home cinemas to create the very best entertainment source whilst not impinging on the design of your home.

Never imagine though that sound reproduction is isolated to one room only and will not be heard elsewhere in the home. Sound from any audio source (a person talking, a conventional speaker, a TV or an Amina speaker) will transfer in air through open doors, ventilation structures, gaps under doors etc, to other areas of the house. Sound will also pass mechanically through the structure of the building (a good example is the central heating boiler. Most homeowners know exactly when it is on!) to other areas quite some distance away.

Whole house/multi-room audio systems are designed to give you the very best audio experience in the space/room you might occupy at any one moment. This does not mean to say that occupiers of other rooms will not hear some of that sound at the same time. They are more than likely to experience it in some lesser level and lesser quality than the intended room.

Please remember therefore that it is not always possible to enjoy the full capabilities of your audio system when other members of the household want to remain undisturbed.

Sound in your Work or Leisure Environment:

Amina products are widely applied in prestigious retail, hotel, restaurant, office, spa and other leisure facilities.

The Amina Active Sound Board technology creates an incredibly even level of sound across an entire space.

This creates an entertaining yet naturally comfortable sound field for users and occupiers.

At the same time the physical embodiment of the speaker is totally unobtrusive, allowing interior designers complete freedom from technology.

Message from the Managing Director

Congratulations and thank you for purchasing an Amina Technologies high performance invisible loudspeaker.

At Amina we are proud of being at the forefront of flat panel active sound board loudspeaker technology. All the components that make up your loudspeaker have been developed specifically to provide the ultimate in sound quality and reliability, whilst allowing you to decorate, furnish and enjoy your home in any way you wish without any visible 'clutter' from your audio system.

At the heart of an Amina loudspeaker is our high performance vibrational panel driver, featuring a unique high power neodymium magnet motor system. This enables the product to provide high quality, high loudness levels from such a compact design. Please take a moment to read this guide which will help you achieve the best possible performance from your product.

Thank you and enjoy listening.

Richard Newlove

MD - Amina Technologies Ltd

About the Manufacturer

Amina Technologies Ltd is the world's leading designer and manufacturer of truly invisible loudspeaker solutions. Our invisible loudspeakers have been used in a wide range of both commercial and residential applications for over twenty years.

Luxurious hotels & spas, exclusive retail outlets and stunning private residences have all benefitted from using Amina invisible loudspeakers, not only for its' incredible aesthetic quality, but for its' absolute ability to reproduce sensationally clear audio across any space. Amina has created the very best discrete audio solution for architects, interior designers and all design conscious clients.

See our website for more details about Amina and a selection of prestigious projects completed using our products.

Interactive PDF guide

This installation guide uses interactive PDF links to choose the installation type that you want.

When you see blue selection boxes with arrows, click or touch one of the boxes to skip to the next section for your type of installation.

You can also click the index return link at the bottom of any page to return to the main index.

An example page is shown below.

The screenshot shows a page titled "14 Installation". Under the heading "Cavity wall or solid wall installation", there is a sub-heading "Cavity wall or solid wall installation" followed by a paragraph: "Check the construction of the wall in your installation." and a bulleted list:

- Cavity wall construction includes walls constructed from plasterboard sheet fixed to wooden or metal 'studs', also drywall construction.
- Solid wall construction covers walls made of brick, block or stone etc with a plaster finishing coat.

Below the list is the text: "Select one of the arrows below to skip to installation instructions for cavity or solid walls." There are two blue selection boxes with arrows pointing right:

- Cavity wall/ceiling installation**
Choose cavity wall installation for any wall or ceiling that is constructed from plasterboard sheet or drywall fixed to wooden or metal studs. Cavity wall installation requires pre-installation of a BackboxCV back box of the correct size.
- Solid wall installation**
Choose solid wall installation for any solid wall that is constructed from brick, block, stone with no additional cavity. Solid wall installation requires pre-installation of a BackboxSW back box of the correct size.

At the bottom of the page is a link: "Click here to return to the index on page 2".

Callout boxes provide instructions:

- A box on the left says: "Click one of these options to skip to the next page in your installation sequence." with arrows pointing to the two blue selection boxes.
- A box at the bottom left says: "Click here to return to the main index." with an arrow pointing to the link at the bottom of the page.

Introduction

Thank you for purchasing Amina invisible loudspeakers. Properly installed, these loudspeakers will provide high quality, invisibly reproduced sound for many years, even decades, to come.

Installation options

Installation is simple, but should only be attempted by professional building trades with plastering experience and who have ideally completed an Amina installation training course.

Amina loudspeakers should be mounted into a wall using the correct fixing accessories, supplied by Amina for each wall type.

Please read these instructions carefully, particularly the Installation section, which contains important advice to select the correct wall-mounting accessories.

This manual should then be read in conjunction with the associated manual supplied with your mounting accessory.

NOTE: This installation guide applies to Mobius and iQ plaster-over loudspeakers only. Edge series loudspeakers are covered in a separate installation guide.

Unpacking

Check that your carton contains the correct number of items - a single speaker, or two if ordered as a pair.

Retain this Installation Guide. If you pass the unit on to a third party make sure you pass on the Installation Guide.

Packaging



CAUTION:

Take care when removing the loudspeakers from the carton.

The packaging for the Amina loudspeakers has been carefully designed to protect the product during transit. Please retain it in the unlikely event you need to return the product to your dealer or to Amina. Please recycle the packaging should you wish to dispose of it, having regard to any recycling regulations in your area.

The outer carton is made up of 80% recycled board.

Overview

1. Electrical connection (to an amplifier)

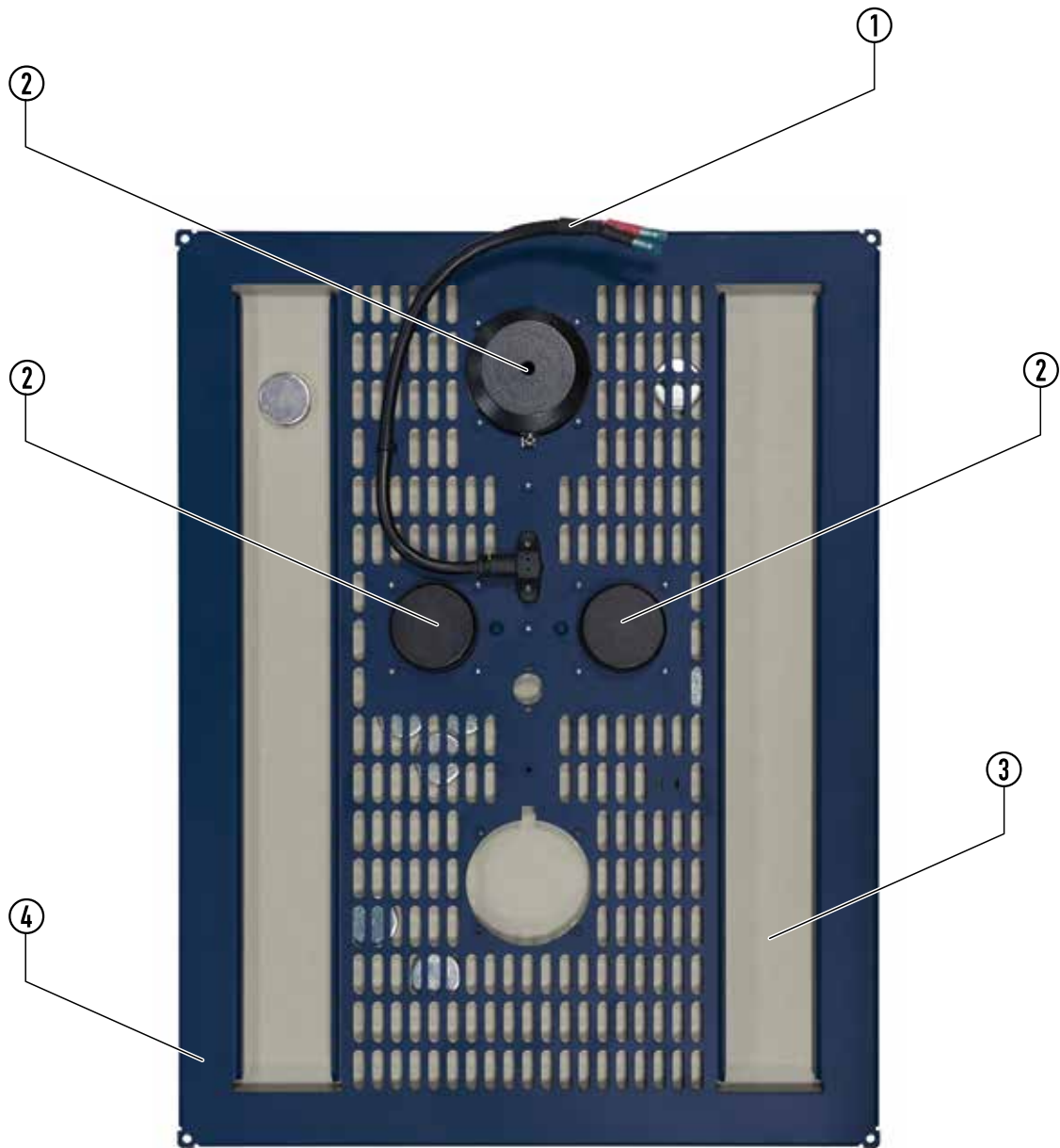

2. High power neodymium magnet structures

3. Active panel surface

4. Aluminium chassis

The Overview image shows a Mobius7

loudspeaker with triple magnet structures. Other models may feature different numbers of magnet structures and electrical connectors.

Setup tips

APU protection

Amina loudspeakers must be used with an APU protection device or another protection device, approved by Amina. Please refer to the instructions supplied with the APU devices and full warranty information for further details.

Installation Backboxes

Amina loudspeakers have been designed for optimum sound quality when installed with the Amina BackboxCV. We recommend that they are used wherever possible in a wall or ceiling cavity type installation. If our basic fixing block kit is used you may find that the low/mid frequencies are reproduced less accurately, but any effect will be very much installation specific.

When installed into solid walls or ceilings using the Amina BackboxSW, you may find that your speaker reproduces slightly less low frequency output compared to a BackboxCV installation. Also, depending on the building construction, there may be significant mechanical sound transmission into adjacent rooms/properties (see page 3).

Wall or Ceiling Placement

Amina loudspeakers are suitable for both wall and ceiling installations. When the most uniform audio coverage in a room is required, space the loudspeakers evenly in the ceiling. However, if the room has a height greater than 6m (19'), Amina suggests installing them in the walls at a height of around 1.8m (6').

In dedicated listening rooms where loudspeakers are used in stereo or multi channel systems, position them in the walls so that the centre point of the speaker is approximately 1 – 1.8m (3.5 - 6') from the floor. This will give excellent results, but don't worry, if this is not possible to achieve in your room, the audio characteristics of Amina loudspeakers make exact positioning according to stereo, 5.1 and 7.1 conventions far less critical.

Audio Characteristics

Amina loudspeakers generate sound in a similar way to an acoustic musical instrument. The speaker's front face is effectively the "musical" soundboard and the sound waves generated from it are diffuse and are dispersed over a very wide angle. This means that loudspeaker positioning is far less critical than with conventional loudspeakers. Additionally, just like the acoustic musical instrument, Amina loudspeakers have excellent room filling abilities.

Amina loudspeakers are planar devices and this feature is further enhanced when flush mounted into your wall or ceiling. Being planar (or flat) means that the audio's arrival time to the listener is the same for all frequencies, i.e. there is very little phase distortion. Therefore Amina loudspeakers (and other planar devices such as electrostatic loudspeakers) can reproduce subtle nuances on a recording with incredible accuracy.

In addition to the above characteristics, the radiating surface of an Amina speaker is very stiff and undergoes very small amounts of movement in order to generate high sound pressure levels. This means that the loudspeakers are inherently "fast" making them highly articulate loudspeakers.

Setup tips

Speaker Orientation

Amina loudspeakers can be installed either in portrait or landscape orientations. Typically the spacing between wall joists will dictate portrait orientation and Amina have optimised the dispersion characteristics for this setup. Therefore when installing into walls Amina suggest portrait orientation for best sound quality.

For non-critical listening in ceiling installations the orientation of the speaker is not crucial.

For critical listening in ceilings, e.g. a 5.1 surround system, ensure that the orientation of all loudspeakers are the same relative to the main listening position and position the top of the speaker closer to the wall or ceiling boundary.

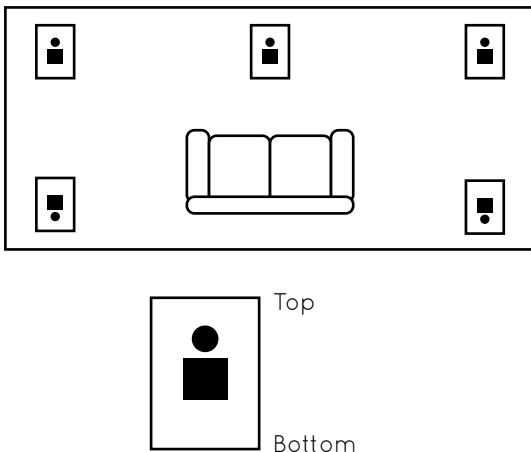

Boundary Loading

It is possible to increase the low frequency output of Amina loudspeakers by positioning them close (50mm - 150mm) to the corners of a room. This can be useful when no additional bass enhancement unit (e.g.. ALF40) or subwoofer (e.g. ALF80 or ALF120) is used.

System Requirements

From a system compatibility point of view your speaker (and it's accompanying APU protection unit) can be treated like any conventional low impedance (4-8 ohm) loudspeaker. Amina recommends you use a good quality amplifier so as to avoid driving them with high levels of distortion, which at best, will provide poor sound quality and at worst may permanently damage the loudspeaker. Amina also recommend you connect your loudspeakers to your amplifier with at least 16AWG OFC (oxygen free) cable (14AWG for long runs) to avoid any chance of reduced efficiency and restricted audio bandwidth.

For 2.1, 5.1 and 7.1 systems always use the amplifier's crossover settings to divert frequencies below 100Hz to your subwoofer. This will improve the dynamic range and power handling of the system. (APU devices should still be used).

IMPORTANT: Amina loudspeakers are highly revealing of any shortcomings in the source or amplifier. Please be aware that some low cost zone amplifiers will produce high amounts of distortion well within their operating range and this will be ruthlessly revealed by Amina loudspeakers.

Sound Transmission

As with any speaker designed to be fixed to a structure within a wall or ceiling, careful consideration should be given to sound transmission into adjacent rooms or properties. We recommend specialist advice is taken if sound transmission into adjacent rooms needs to be minimised. Please talk to the Amina technical team for advice on reducing sound transmission as a starting point.

100/70V Option

For multi-speaker commercial installations, please contact Amina for their range of loudspeakers supplied with 100V or 70V line transformers fitted.

Installation





IMPORTANT: Read this section carefully before attempting to install an Amina speaker.

To avoid any possible damage to Amina invisible loudspeakers they must be mounted and connected using the correct accessories, supplied by Amina. The tables to follow list these accessories.

Mounting accessories

Identify the construction type of the wall/ceiling where the loudspeakers are to be installed and ensure you have the correct fixing accessories to hand before installing your loudspeakers.

Full installation instructions are available for each type of mounting accessory.

Type	Application	Image
BackboxCV300 BackboxCV345 BackboxCV200 For cavity walls and ceilings	Used to install loudspeakers in cavity walls and ceilings to reduce airborne sound generation from the rear of the speaker and create an optimum acoustic cavity.	
Firehood 300 Firehood 345 Firehood 200 For fire-rated ceilings	A 60 minute fire rated overjacket to use with the BackboxCV, which maintains 1 hour fire-retardency, where necessary, and additionally reduces airborne sound generation from the rear of the speaker.	
Basic fixing block kit For cavity walls	Used to install loudspeakers in cavity walls and ceilings, where depth limitations dictate that BackboxCV cannot be used.	
BackboxSW300 BackboxSW345 BackboxSW200 For solid walls	A stainless steel backbox to build into solid walls prior to speaker installation.	
Shims	Various thicknesses available to align the speaker with the front of non-standard plasterboard structures.	

Refer to the Installation guide available for the above mounting accessories for detailed fitting instructions of the accessory, together with how the loudspeaker is used within it.

Installation

Speaker protectors

Amina APU series speaker protectors are specifically designed to work with Amina invisible loudspeakers. They provide essential safe operating functions and include protection elements that constantly monitor the power fed to the speaker keeping it within safe limits should temporary excessive audio levels be applied to the loudspeaker.

An Amina speaker protector should be wired in-line with each Amina speaker, preferably in an accessible place, allowing this device to be replaced as necessary.



APU devices are designed to work with a single speaker. Never connect more than one speaker onto a single APU protection device.

However, common sense should always prevail. Your product should never be operated at repeated or consistently high audio levels. Never operate your Amina speaker at a level where audio reproduction appears distorted.





For the ultimate in protection and performance, use the Amina A100Q multi-channel amplifier.

Refer to the table on the next page for more detail of protection options for short to medium periods of time.

Installation

Speaker protectors

There are four types of protector.

Type	Application	Image
APU-RS8i	Flexible 8 channel crossover and protection unit in a 1U case for optional rack mounting. Provides protection for installations of up to 8 Amina loudspeakers.	
APU-RS16i	16 channel crossover and protection unit in a single 1U case. Provides protection for up to 16 Amina loudspeakers.	
APUi	Single channel crossover and protection for wiring in-line with each Amina speaker. APUi crossovers are available in different versions and must be ordered to match the speaker being installed.	
A100Q amplifier Ultimate speaker protection	Absolute protection of a loudspeaker is possible by sensing and controlling output voltages within the amplifier driving that loudspeaker. The Amina A100Q amplifier integrates clean and powerful amplification (4 channels at 100W each) with sophisticated digital sensing and control technology to deliver the ultimate protection for your Amina invisible speaker. It both prevents excessive audio signals from ever reaching the speakers whilst allowing them to perform at their absolute peak at all times. This is achieved thanks to some clever internal digital signal processing software that knows exactly how to get the best from each speaker.	

Installation

Cavity wall or solid wall installation

Check the construction of the wall in your installation.

- Cavity wall construction includes walls constructed from plasterboard sheet fixed to wooden or metal 'studs', also drywall construction.
- Solid wall construction covers walls made of brick, block or stone etc with a plaster finishing coat.

Select one of the arrows below to skip to installation instructions for cavity or solid walls.

Cavity wall/ceiling installation

Choose cavity wall installation for any wall or ceiling that is constructed from plasterboard sheet or drywall fixed to wooden or metal studs. Cavity wall installation requires pre-installation of a BackboxCV back box of the correct size.

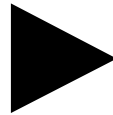

Solid wall installation

Choose solid wall installation for any solid wall that is constructed from brick, block, stone with no additional cavity. Solid wall installation requires pre-installation of a BackboxSW back box of the correct size.

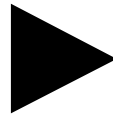

Installation (cavity walls)

Correct fixing method for BackboxCV

By way of an example installation, the following details the method of installing an Amina loudspeaker in a stud wall with a BackboxCV and finished with a full skim of plaster.

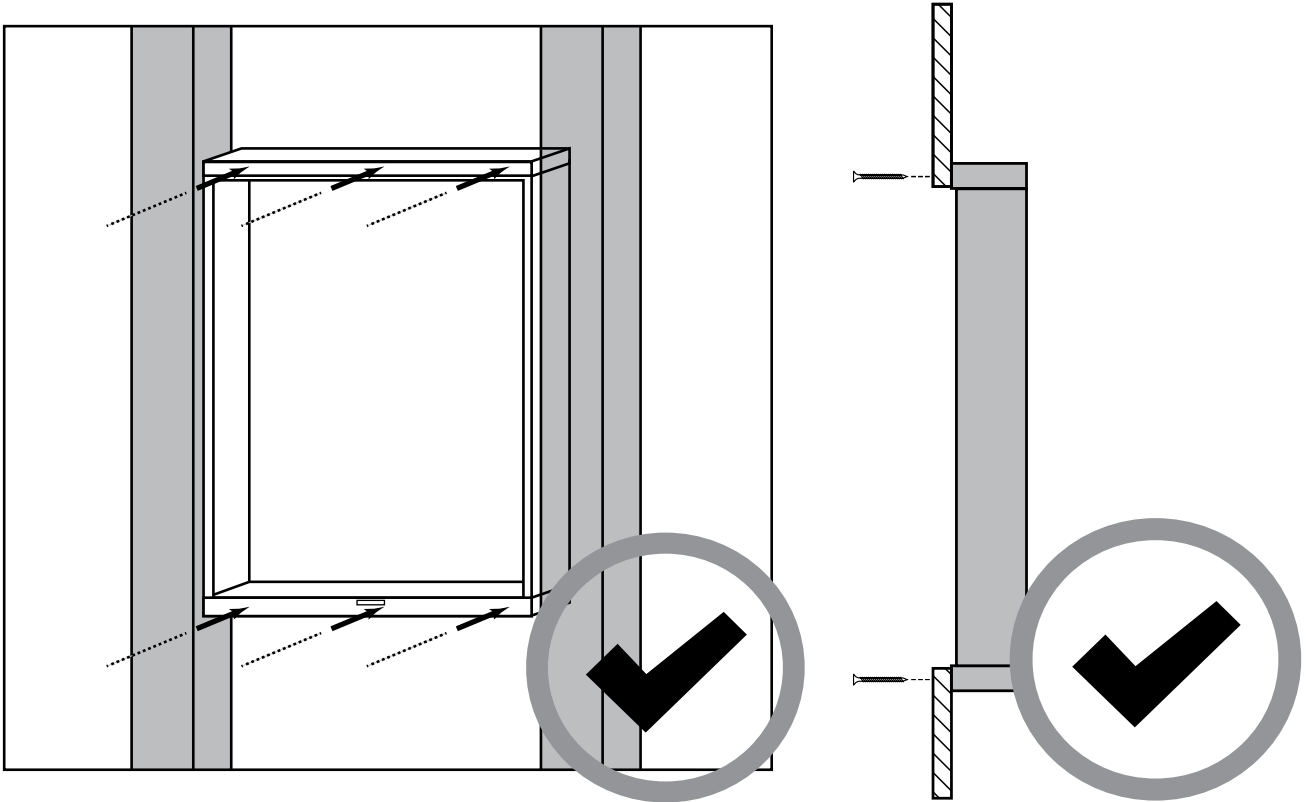

IMPORTANT:

The BackBoxCV **must** be fixed to the plasterboard only. **Never** attach directly to the stud work or near supporting structure as shown in the images below.

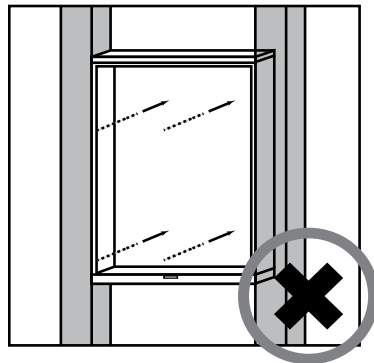
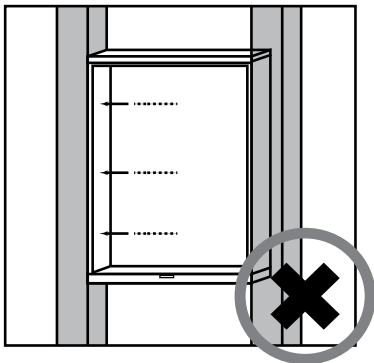

Installation (cavity walls)

Locate joist work

When you have chosen your speaker locations, before cutting a hole in the plasterboard it is important that you locate the position of the wall studs. Ensure the spacing between them is at least 5mm greater than the width of your Amina loudspeaker for a portrait orientated speaker.

If necessary cut an inspection hole in the plasterboard, use a tape measure inserted through the hole to accurately locate the edges of studs.

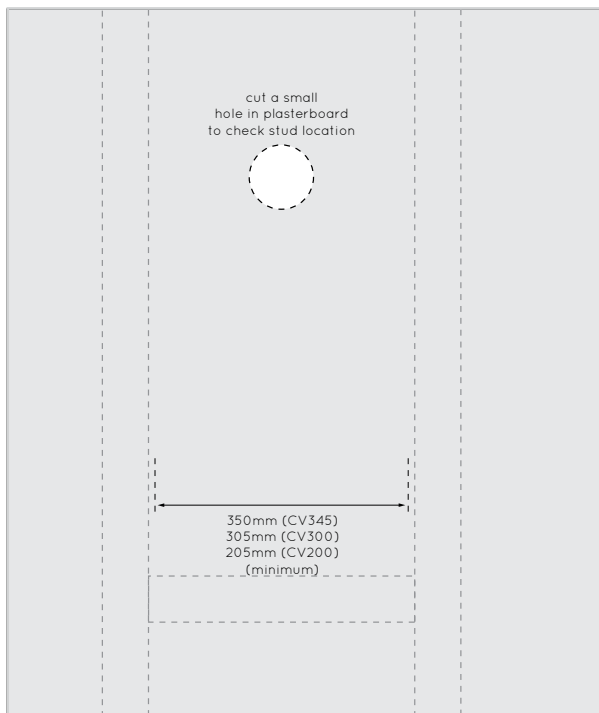

Using the Template for pre-install of BackboxCV

Staple or tape the template side of the Quick Reference Guide to the plasterboard/drywall to act as a template.

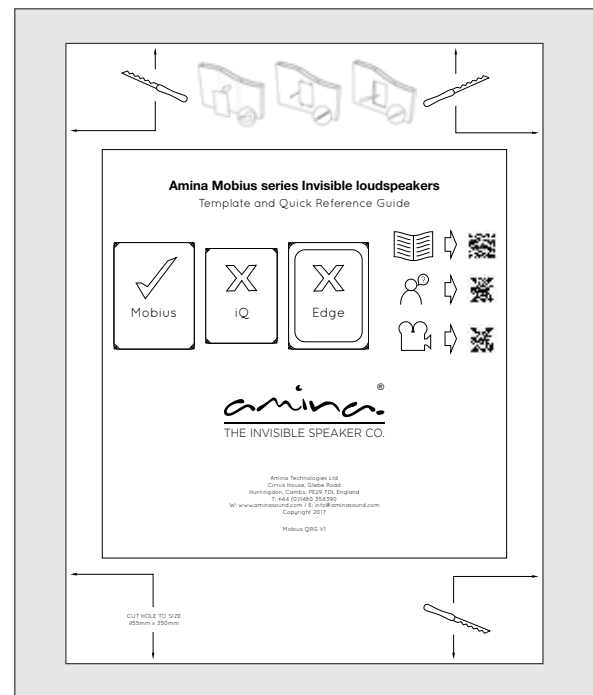

Using the Cutout Template

1. Ascertain joist position behind plasterboard/ drywall.
2. Ensure cut out dimensions fit between the joists.
3. Use a knife to cut around the outside of the template.

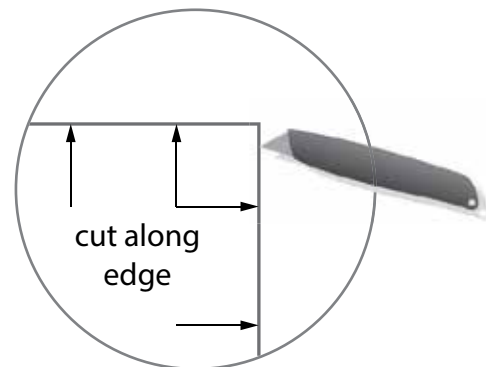

Installation (cavity walls)

Installing the BackboxCV

Check which version of the BackboxCV you have before following this section

Create 455 x 205mm (17 7/8" x 8 1/8") aperture (CV200).

Create 405 x 305mm (15 7/8" x 12") aperture (CV300).

Create 455 x 350mm (17 7/8" x 13 3/4") aperture (CV345).

Using a sharp knife or pad saw, cut an aperture in your plasterboard wall or ceiling. Ensure the aperture is created between supporting joists or stud work.

We strongly advise that joists are not cut to make space for the backbox. Any activity of this sort may well influence the structural integrity of your property.

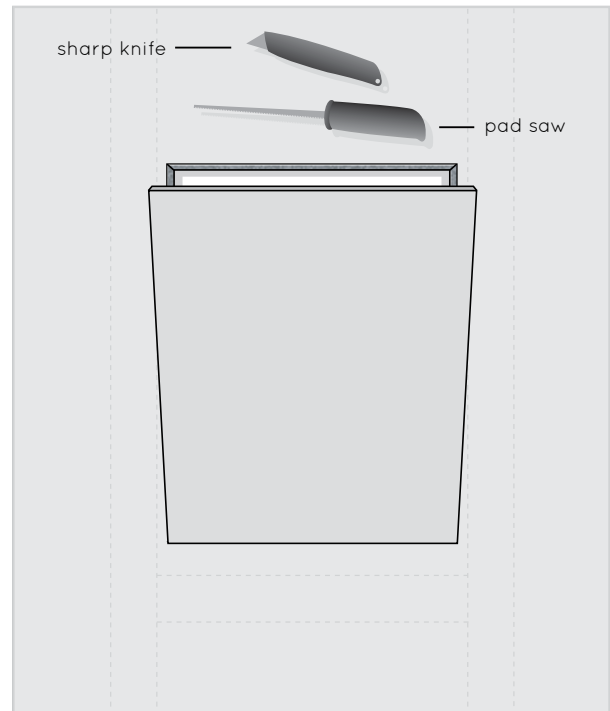

IMPORTANT:

Double check the size of the aperture, as this is important further on into the installation process.

Installation (cavity walls)

Shims

Once the hole is cut for the BackboxCV it is important to identify the substrate thickness.

You may need to fix shims to the speaker frame or to the BackboxCV to correctly align the speaker.

The thickness of the shims required is shown in the alignment guide to follow and will depend on the construction of the wall and the thickness of any pre-existing plaster skim.

Shim sizes

Standard 12.5mm (1/2") drywall

No shims are required for installation in 12.5mm drywall. For other drywall thicknesses, shims will be necessary.

Thicker drywall

For thicker drywall, subtract 12.5mm from the thickness of the drywall to determine the shim size. Fix the shims to the mounting face of the speaker.

Thinner drywall

For thinner drywall, subtract the drywall thickness from 12.5mm to determine the shim size. Fix the shims to the mounting face of the BackboxCV.

Fixing shims to the speaker

Some installations will require shims fixed to the speaker mounting face to compensate for the thickness of plaster skim. This arrangement is shown below.

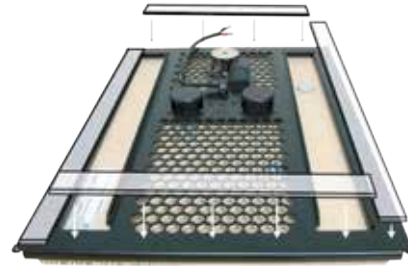

Fixing shims to the BackboxCV

Some installations will require shims fixed to the BackboxCV mounting face to compensate for thinner drywall or plasterboard. This arrangement is shown below.

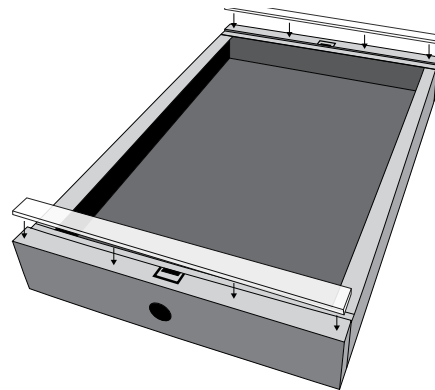

Installation (cavity walls)

Cavity wall alignment options

The next section describes different cavity wall alignment options. Choosing the correct alignment is essential in achieving the best performance and finish from your Amina speaker installation.

The correct alignment is determined by the construction of the wall/ceiling, with some alignments offering different finishing alternatives.

Select one of the options below to skip to the alignment and finishing options for your installation.

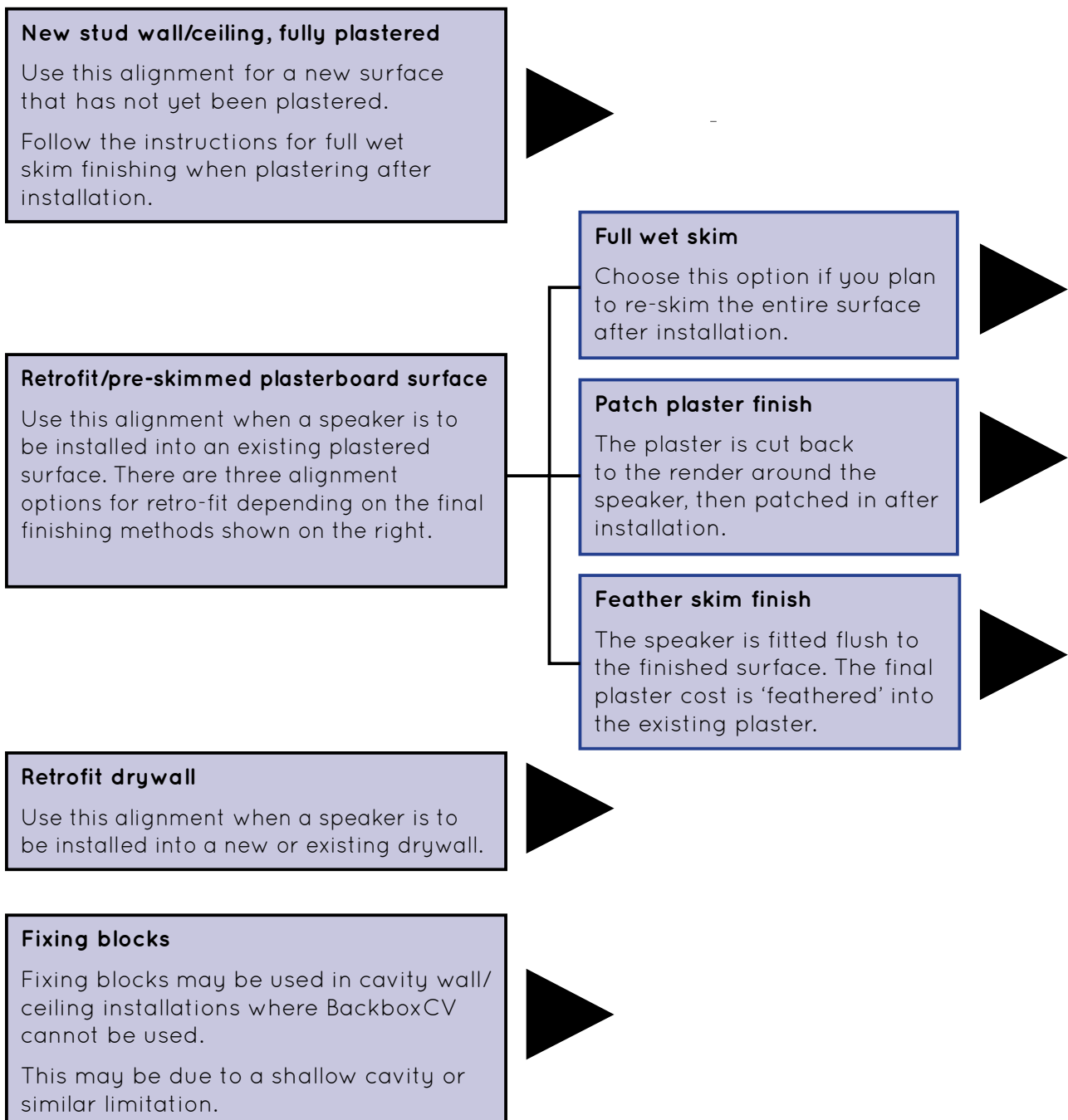

Installation (cavity walls)

Alignment and preparation

For new stud walls / ceilings using BackboxCV

Alignment required for plastering

The diagram shows a loudspeaker fitted into a BackboxCV in a new stud wall.

When correctly installed, the surface of the speaker panel will align with the surface of the plasterboard.

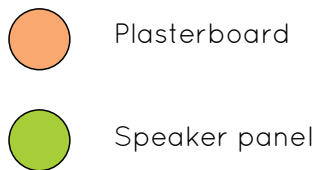

Full wet skim finishing

Align the speaker as shown, then select continue below to skip to fitting and testing the speaker.

When the speaker is fitted and tested, choose **Full Wet Skim** finishing to complete the installation.

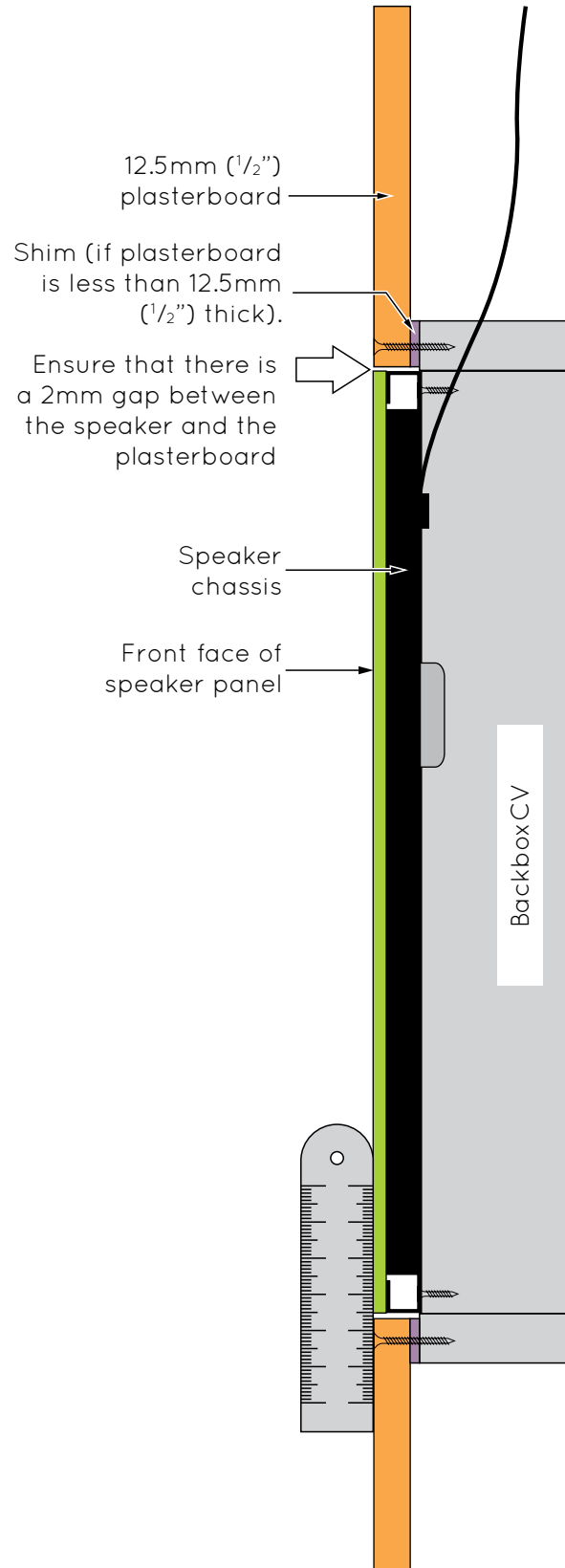

CONTINUE

To Connecting and Fixing the speaker.







Installation (cavity walls/ceilings)

Alignment and preparation

Retrofit / pre-skimmed plasterboard (full wet skim finish)

Alignment required for plastering

Using a 2-3mm shim set (contact your Amina supplier) between the back of the speaker and the mounting surface of the backbox, the front face of the speaker should be flush with the front face of the existing painted/plastered wall/ceiling.

-  Plasterboard
-  Speaker panel
-  Existing plaster
-  Shim

Full wet skim finishing

Align the speaker as shown, then select continue below to skip to fitting and testing the speaker.

When the speaker is fitted and tested, choose **Full Wet Skim** finishing to complete the installation.

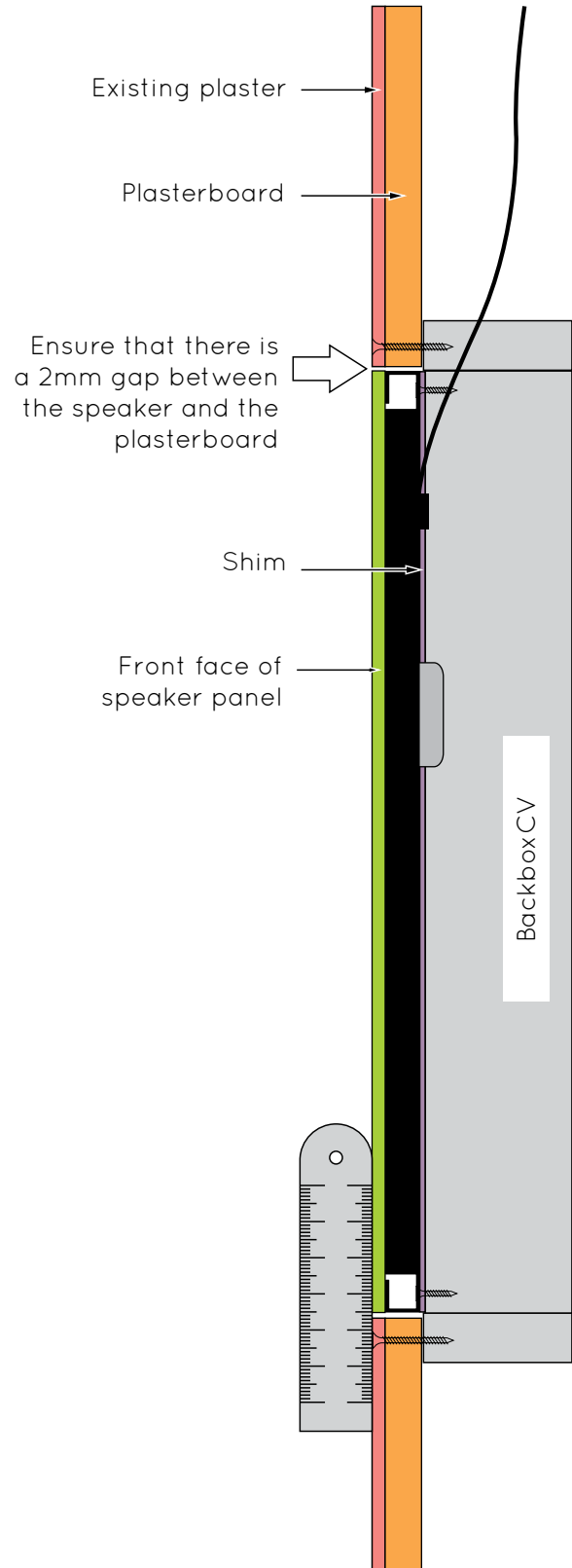

CONTINUE

To Connecting and Fixing the speaker.





Installation (cavity walls)

Alignment and preparation

Retrofit / pre-skimmed plasterboard (patch plastered finish)

Alignment required for plastering

After removing a 30-50mm (approx 2") wide section of existing plaster surrounding the cut out, the front face of the speaker should be flush with the paper face of the plasterboard.

-  Plasterboard
-  Speaker panel
-  Existing plaster

Patch plaster finishing

Align the speaker as shown, then select continue below to skip to fitting and testing the speaker.

When the speaker is fitted and tested, choose **Patch Plaster** finishing to complete the installation.

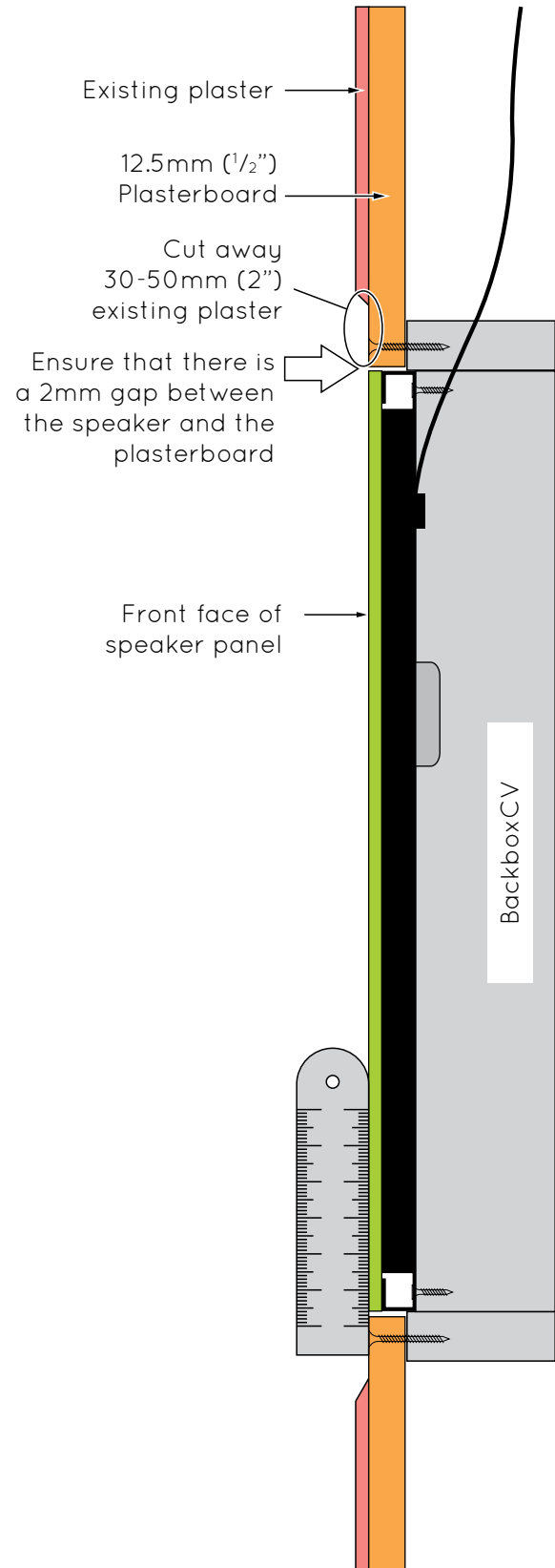

CONTINUE

To Connecting and Fixing the speaker.





Installation (cavity walls)

Alignment and preparation

Retrofit / pre-skimmed plasterboard (feathered skim finish)

Alignment required for plastering

Using a 2-3mm shim set (contact your Amina supplier) between the back of the speaker and the mounting surface of the backbox (or fixing blocks), the front face of the speaker should be flush with the front face of the existing painted/plastered wall/ceiling.

-  Plasterboard
-  Speaker panel
-  Existing plaster
-  Shim

Feather finishing

Align the speaker as shown, then select continue below to skip to fitting and testing the speaker.

When the speaker is fitted and tested, choose **Feather** finishing to complete the installation.

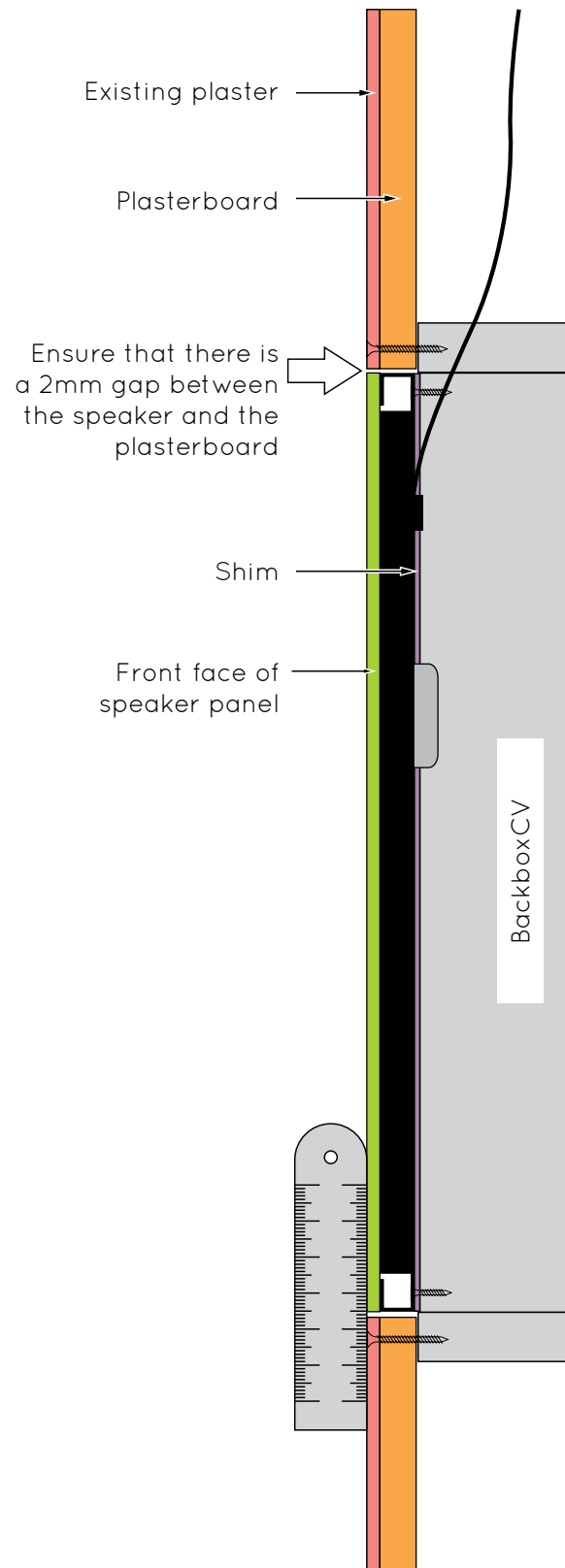

CONTINUE

To Connecting and Fixing the speaker.



Installation (cavity walls)

Alignment and preparation

Retrofit or new drywall

Alignment required for plastering

For new drywall walls /ceilings that will be taped and jointed.

(typically in North America but becoming common elsewhere)

The front face of the speaker should be flush with the face of the new wall/ceiling if correctly installed.

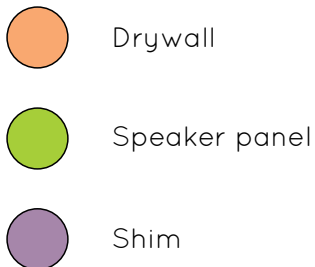

Feather finishing

Align the speaker as shown, then select continue below to skip to fitting and testing the speaker.

When the speaker is fitted and tested, choose **Feather** finishing to complete the installation.

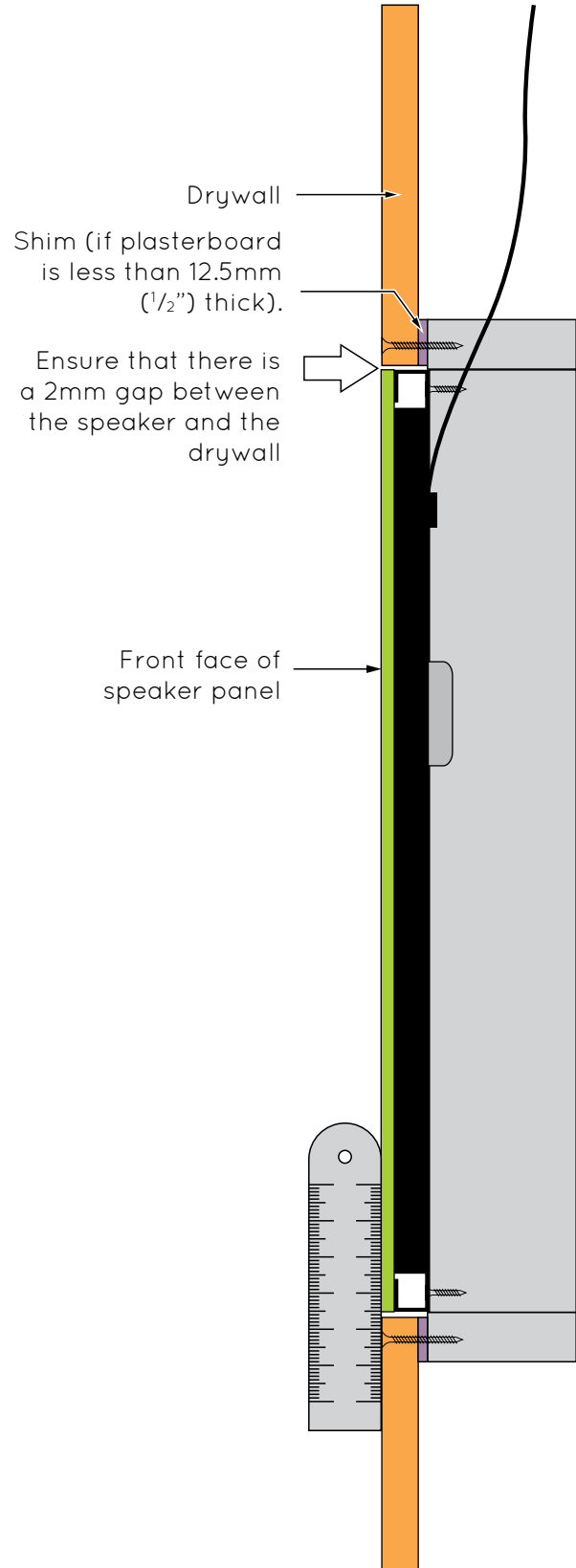

CONTINUE

To Connecting and Fixing the speaker.



Installation (cavity walls)

Alignment and preparation

For new stud walls / ceilings using Fixing Blocks

Alignment required for plastering

Fixing Blocks are used in installations where BackboxCV cannot be used.

The diagram shows a loudspeaker fitted in a new stud wall with Fixing Blocks.

When correctly installed, the surface of the speaker panel will align with the surface of the plasterboard.

A shim may be necessary to achieve the correct alignment.

The cavity behind the speaker is packed with acoustic wadding to reduce back radiated sound.

- Plasterboard
- Fixing block
- Speaker panel
- Shim

The view below shows a speaker fitted with mounting blocks. The plasterboard is cut away from the top right Fixing Block to show correct alignment of the block behind the plasterboard.

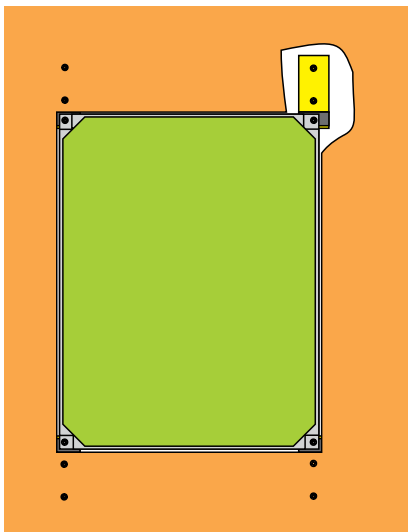

CONTINUE
To Connecting and Fixing the speaker.

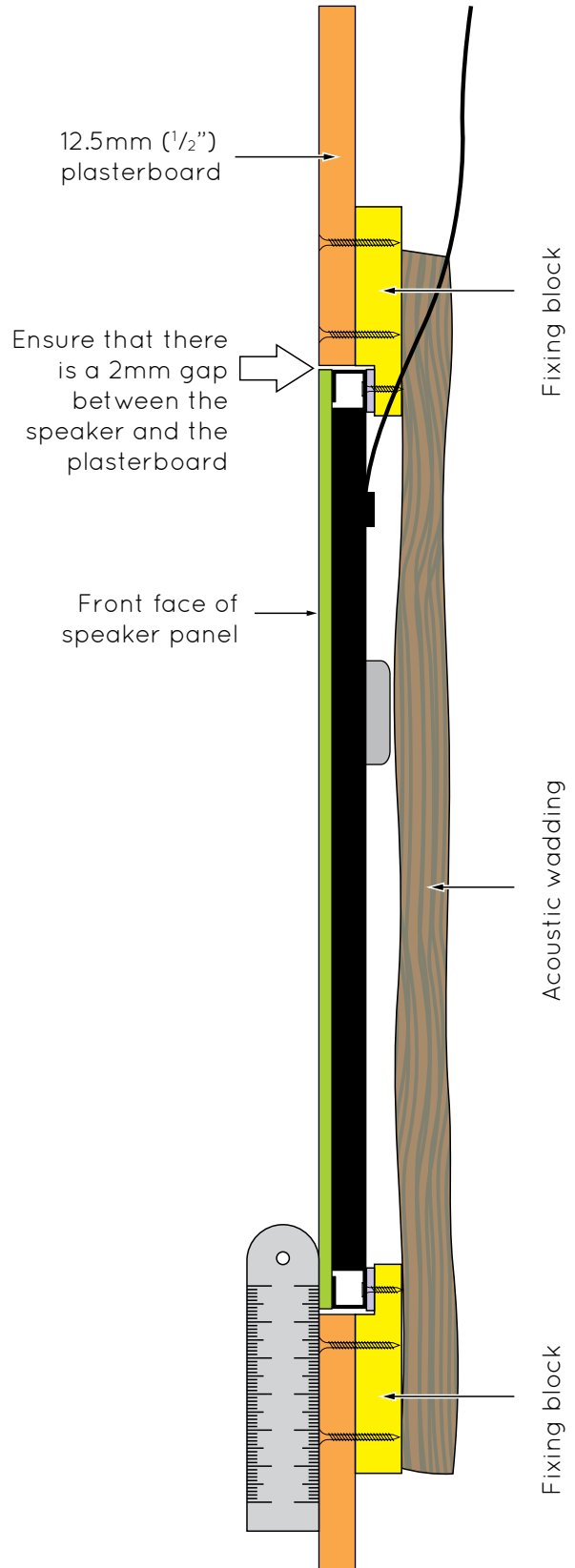

Installation (cavity walls)

Connecting the speaker

- Fit a pad of acoustic wadding into the BackboxCV.
- Crimp the wiring from the amplifier into the butt splice on the speaker wires.



Make sure that connection polarity is maintained. One of the wires from the amplifier should be marked for polarity. This will be by colour, a stripe or a rib along the edge of the wire. Connect this wire to the red (+) wire of the speaker.

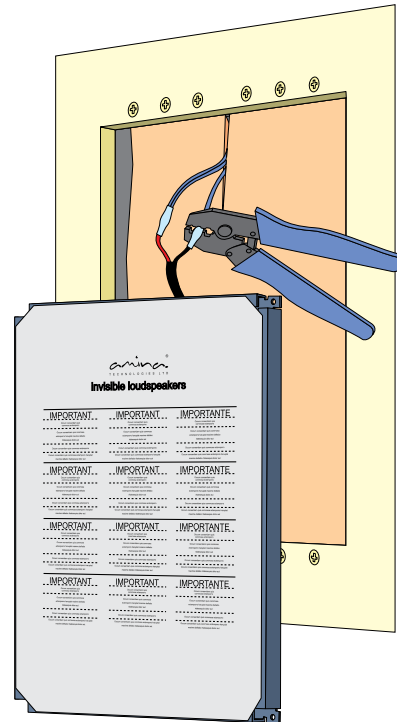

Fixing the speaker

- With the speaker resting on the speaker mounting lip use the flange head screws provided to secure the speaker onto the BackboxCV by self tapping into the speaker mounting lip, through the speaker fixing holes.
- Ensure the speaker face is aligned correctly, centrally in the BackboxCV opening, and that everything is firmly held in position.

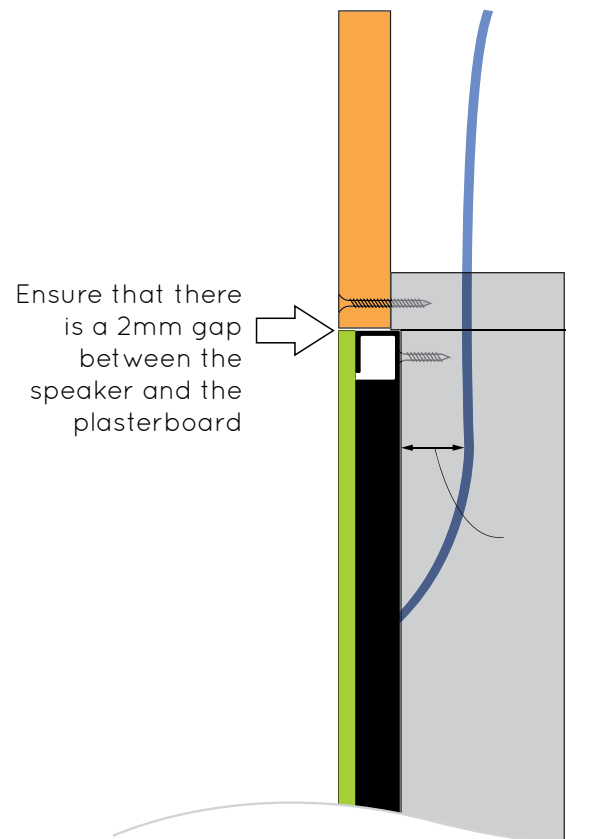

CONTINUE

To Testing and Finishing the installation.



Installation (solid walls)

Using BackboxSW

Create aperture in brickwork/ concrete.

Using the combination of an angle grinder and a jackhammer drill, create a cavity within the brickwork of -

- 460mm x 355mm (18¹/₈" x 14") for Mobius speakers using BackboxSW345
- or
- 410mm x 310mm (16" x 12¹/₄") for iQ speakers using BackboxSW300.

Before installing the backbox you will need to know the thickness of render that will be applied to the wall/ceiling prior to the finish plaster skim.

Minus that thickness from 50mm (2") to calculate the minimum cavity depth you will need to create.

NOTE: In poured concrete ceilings and walls create an appropriate form in your shuttering before pouring concrete.

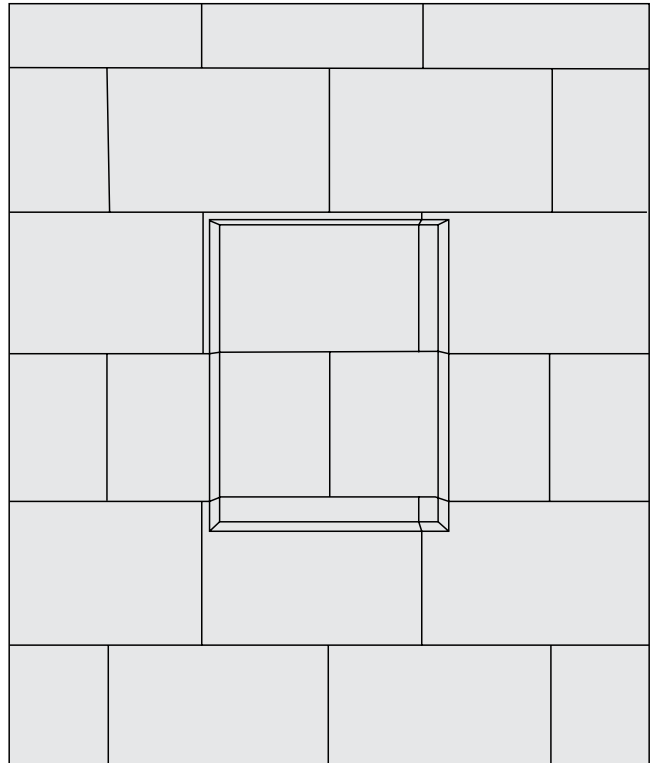

Create channel for cable

Using an angle grinder or hammer and chisel, create a channel that runs into this cavity, this will allow the speaker cable to be pulled into a suitable position within the cavity.

We recommend the cable is run in a suitable conduit to protect it.

Leave enough cable slack to allow connection to the speaker when it is held away from the cavity.

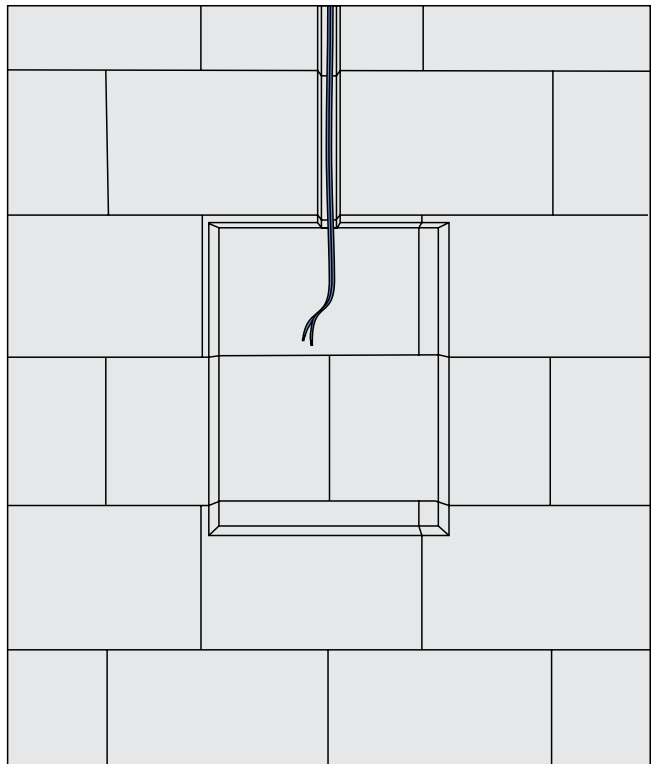

Installation (solid walls)

Solid wall alignment options

The next section describes different solid wall alignment options. Choosing the correct alignment is essential in achieving the best performance and finish from your Amina speaker installation.

The correct alignment is determined by the construction of the wall/ceiling, with some alignments offering different finishing alternatives.

Select one of the boxes below to select the alignment option for your installation and jump to the next page.-

New build/New solid walls cutaway (Full wet skim finish)

For solid walls /ceilings that are yet to be rendered or have already been rendered but not yet plaster skimmed.

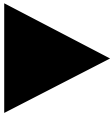

Retrofit / pre-skimmed solid wall cutaway (Patch plaster finish)

For solid walls /ceilings that have already been plastered and painted. The plaster is cut back to the render around the speaker, then patched in after installation.

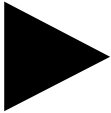

Retrofit / pre-skimmed solid wall cutaway (Feathered plaster finish)

The speaker is fitted flush to the wall surface. The final plaster cost is 'feathered' into the existing plaster.

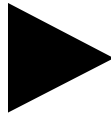

Installation (solid walls/ceilings)

Alignment and preparation

New build/New solid walls cutaway (Full wet skim finish)

For solid walls /ceilings that are yet to be rendered or have already been rendered but not yet plaster skimmed.

Cavity depth

The cutaway drawing on the right shows the alignment of the BackboxSW in the cavity.

- Temporarily remove the denim pad.
- Use shims between the back of the BackboxSW and the inside of the cavity to align the front edge of the silicon trim with the (eventual) front face of the base coat render.
- Use expanding foam to fill any cavities behind and to the sides of the BackboxSW.
- If base coat render is not in place, render up to the plastic trim.
- Once the render is dry, remove the silicon trim and replace the denim pad ready for installation of the loudspeaker and then application of the final skim coat.

Full wet skim finishing

Align the speaker as shown, then select continue below to skip to fitting and testing the speaker.

When the speaker is fitted and tested, choose **Full Wet Skim** finishing to complete the installation.

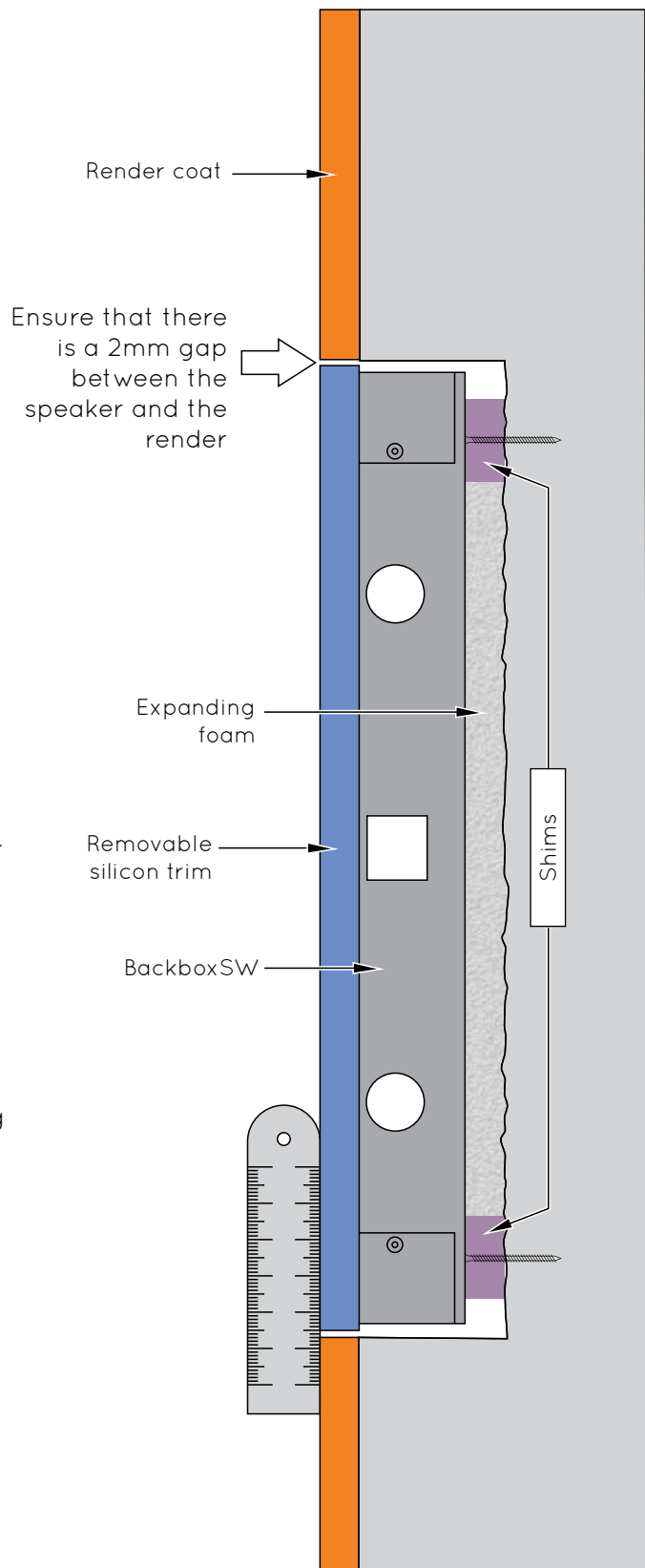

CONTINUE

To Connecting and Fixing the speaker.



Installation (solid walls/ceilings)

Alignment and preparation

Retrofit / pre-skimmed solid wall cutaway (Patch plaster finish)

This is an alternative to feathered skim installation.

For solid walls /ceilings that have already been plastered and painted.

Cavity depth

The cutaway drawing on the right shows the alignment of the BackboxSW in the cavity.

- Temporarily remove the denim pad.
- Use shims between the back of the BackboxSW and the inside of the cavity to align the front edge of the silicon trim with the front face of the render.
- Use expanding foam to fill any cavities behind and to the sides of the BackboxSW.
- Replace the denim pad.
- When the BackboxSW is fixed securely into the cavity, remove the silicon trim ready for installation of the loudspeaker and then application of the final skim coat.

Patch plaster finishing

Align the speaker as shown, then select continue below to skip to fitting and testing the speaker.

When the speaker is fitted and tested, choose **Patch Plaster** finishing to complete the installation.

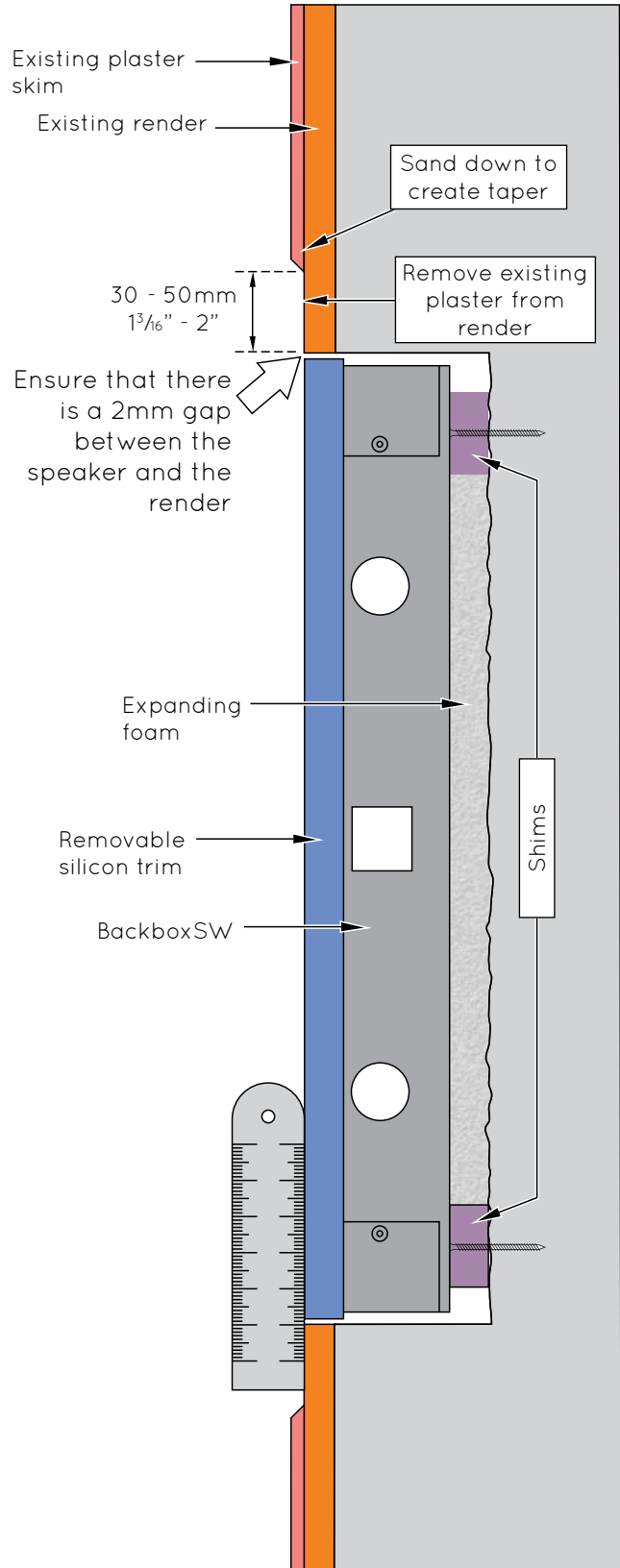

CONTINUE

To Connecting and Fixing the speaker.



Installation (solid walls/ceilings)

Alignment and preparation

Retrofit / pre-skimmed solid wall cutaway (Feathered plaster finish)

For solid walls /ceilings that have already been plastered.

Cavity depth

The cutaway drawing on the right shows the alignment of the BackboxSW in the cavity.

- Temporarily remove the denim pad.
- Use shims between the back of the BackboxSW and the inside of the cavity to align the front edge of the silicon trim with the front face of the finished wall.
- Use expanding foam to fill any cavities behind and to the sides of the BackboxSW.
- Replace the denim pad.
- When the BackboxSW is fixed securely into the cavity, remove the silicon trim ready for installation of the loudspeaker and then application of the final skim coat.

Feather finishing

Align the speaker as shown, then select continue below to skip to fitting and testing the speaker.

When the speaker is fitted and tested, choose **Feather** finishing to complete the installation.

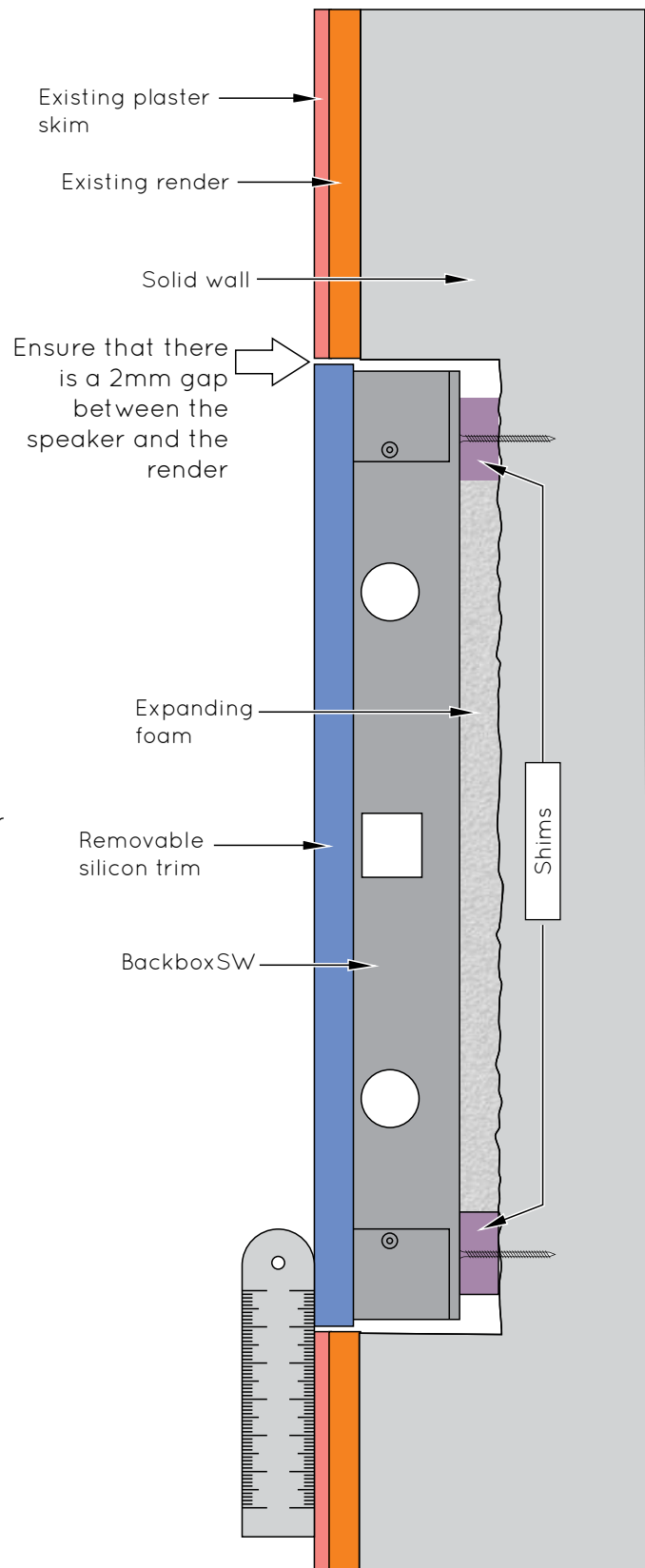

CONTINUE

To Connecting and Fixing the speaker.



Installation (solid walls/ceilings)

Connecting the speaker

- Re-fit the denim damping pad into the BackboxSW.
- Crimp the wiring from the amplifier into the butt splice on the speaker wires.



Make sure that connection polarity is maintained. One of the wires from the amplifier should be marked for polarity. This will be by colour, a stripe or a rib along the edge of the wire. Connect this wire to the red (+) wire of the speaker.

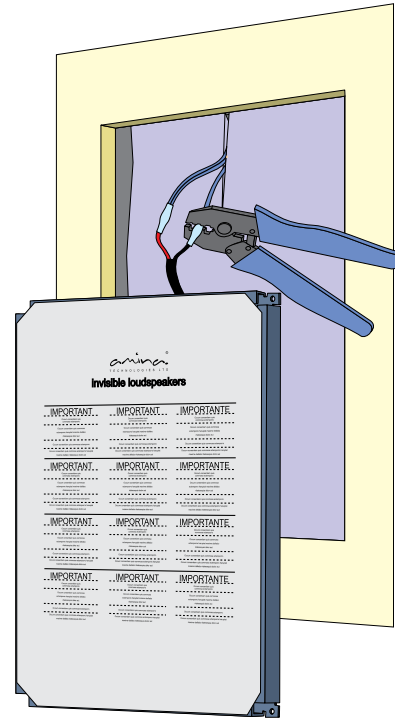

Fixing the speaker

- Remove the backing paper from the 6 adhesive pads on the speaker mounting tabs.



It is imperative that the foam pads remain in place.

- Carefully position the speaker onto the mounting tabs then apply moderate pressure.

There should be an equal perimeter gap between the BackboxSW and the edge of the speaker.

- Use the flange head screws (supplied with the BackboxSW) to fix the corners of the speaker to the four corner mounting tabs.

Each tab includes a pre-drilled hole under the foam pad.

Top view

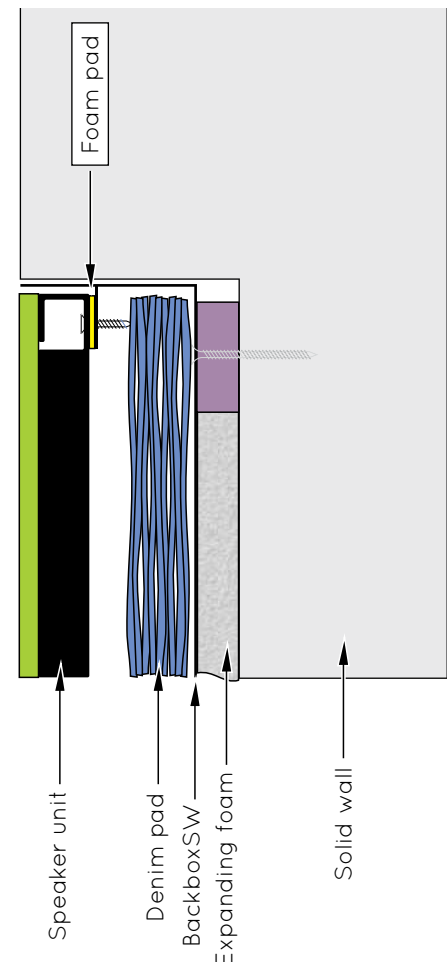

CONTINUE

To Testing and Finishing the installation.



Testing

Testing the speaker

At this stage the speaker must be tested. If any problems are found the speaker can be easily removed before plastering.



CAUTION:

Do not use a battery or DC voltage supply to check continuity or phase check as there is no forward or backward movement of the panel.

DC voltage can damage the speaker.

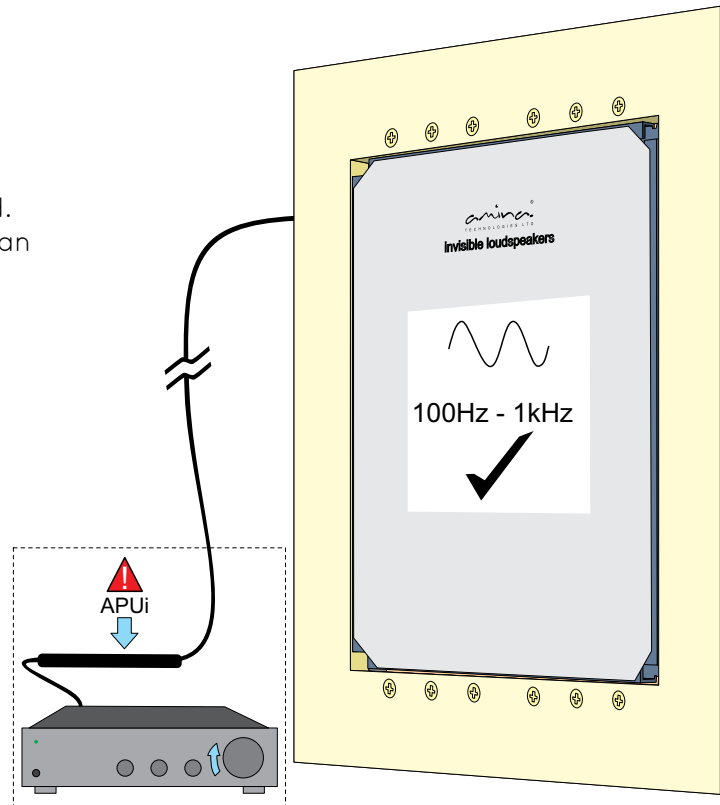

Resistance test

Using a multimeter and without the APU protection device connected, check the nominal impedance (DC resistance) of the speaker at the amplifier end of the speaker cable.

Allowing for approx. +10% for cable resistance, the measured impedance should coincide with the values on the respective loudspeaker datasheets.

If it measures significantly differently, check for breaks or shorts in the cable.



CAUTION:

Connect the APU protection device

Once the resistance test is successfully completed, connect the APU protection unit at the amplifier end of the cable before proceeding with further tests.

Sweep test

Amina recommends a tone sweep be used at a moderate volume level (0.5 Vrms). Such a test will quickly highlight any buzzes or rattles that could be caused by loose screws, cables touching the speaker or loose elements/studs within the wall/ceiling itself.

NOTE: A tone sweep test must be run initially as it is the most reliable test for buzz and rattle. Music tests are useful, optional tests for final confirmation.

Music test

Play music to check for buzzes and rattles during transient peaks: if these are apparent, check the above points again. The overall speaker performance must be clean and distortion free.

Problems during test

If the tests reveal any rattles or buzzes, refer to the next section for help to find the cause.

Testing

Problems during test

If you encounter any rattling or buzzing problems during test, check the following section to resolve these issues.



CAUTION:

Never proceed with plastering until the speaker has passed both sweep and music tests.

The following list may help you trace the cause of any rattling or buzzing problems.

Insecure drywall

If the drywall is not securely fastened to the joists, this could create a buzz or a rattle. Apply more screws to secure the drywall if necessary - particularly around the speaker location.

Metal studs

If metal studs are used, ensure all crossover points within the studs are secured together. This can be achieved by applying drywall screws through the wall surface and through the metal crossover points.

If they are not secure this may well lead to audible vibrations and rattles.

Cable buzzing

Ensure that the speaker cable is not touching any part of the speaker as this can lead to buzzes and rattles. To avoid this it is advised to lay the cable behind mineral wool, recycled cotton or other wadding.

Lighting fixtures

Ensure lighting fixtures, especially those closer to the loudspeakers are of a solid construction and are firmly fixed in place.

Finishing

Filling the perimeter

Ensure a 1.5mm to 2mm gap exists around the speaker between it and the plasterboard. No gap at all or an excessive gap may lead to future cracking.

Once the speaker is fixed into place, the gap must be filled with plaster joint filler to bond the edge of the panel to the edge of the plasterboard.



The joint filler should significantly penetrate the edge gap.

Wipe away excess joint filler from the panel surface (both the outer perimeter and raised sections).

Use a low shrinkage joint filling plaster such as British Gypsum Gyproc-Joint-Filler or other joint compound.

This will prevent cracking around the border.



Allow this to dry fully before continuing with the installation.



Speaker panel



Plaster to fill the edge

Fill the gap between the speaker panel and the wall

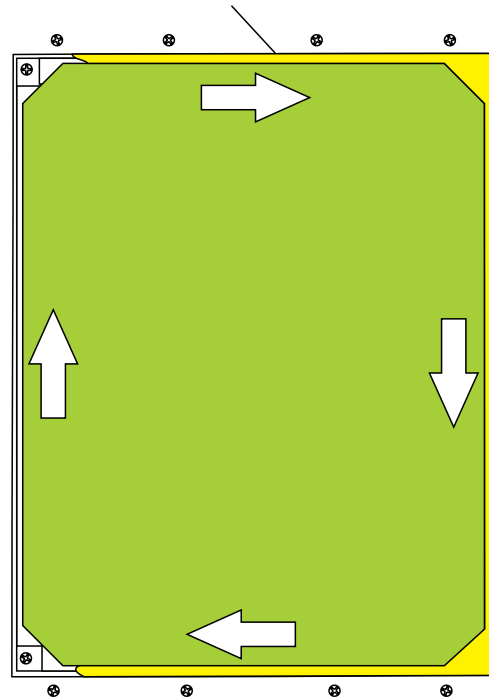

Taping the joints and panel surface

Apply professional plasterboard self-adhesive fibreglass joint scrim to the speaker face. Ensure it covers the entire speaker face and the plasterboard joint.

Amina can provide rolls of 500mm wide adhesive scrim to do this in one operation. Alternatively, use multiple strips of narrower scrim tape.

This provides increased surface area for the plaster skim coat to bond to the panel surface.

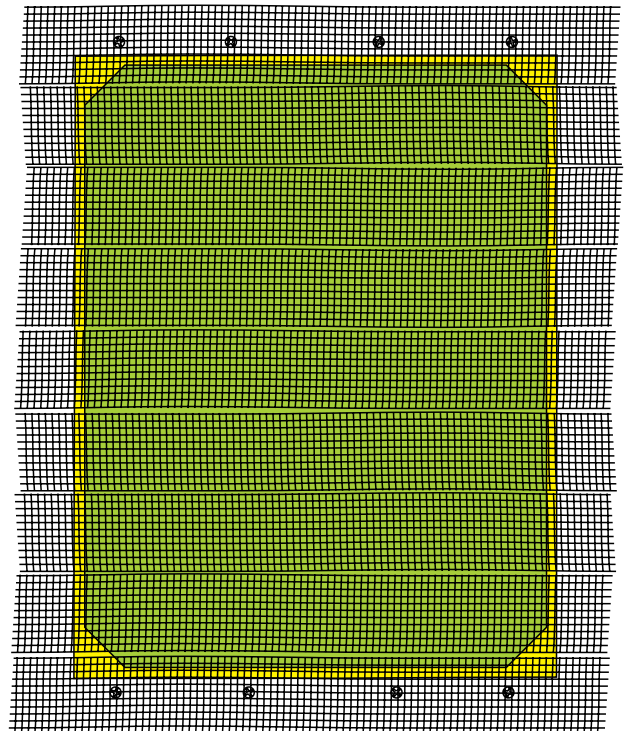

Finishing

Plastering options

The next section describes three different plaster finishing options.

You must use the finishing option for the speaker alignment that you chose when installing the speaker in the wall.

Select one of the options below to skip to the finishing method for your installation -

Full plaster skim coat

When the wall/ceiling is to be fully plastered.

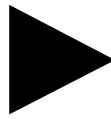

Patch plaster finish

For retrofit installations where the plaster has been cut back to the plasterboard or render around the border of the speaker.

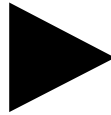

Feather skim finish

For retrofit installations where the plaster was not cut away around the border of the speaker. For this method the speaker and approx 1m² surrounding wall are over-plastered with a feather edge.

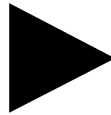

Finishing

Full plaster skim coat

Apply plaster skim coats to entire wall surface and loudspeaker.



The maximum total plaster thickness must be no more than 2mm.



The working environment must be dry enough to allow the plaster finish coat to dry within hours, not days.



Speaker panel



Plaster to fill the edge



Surface skim coat



Original plaster (if any)



Plasterboard

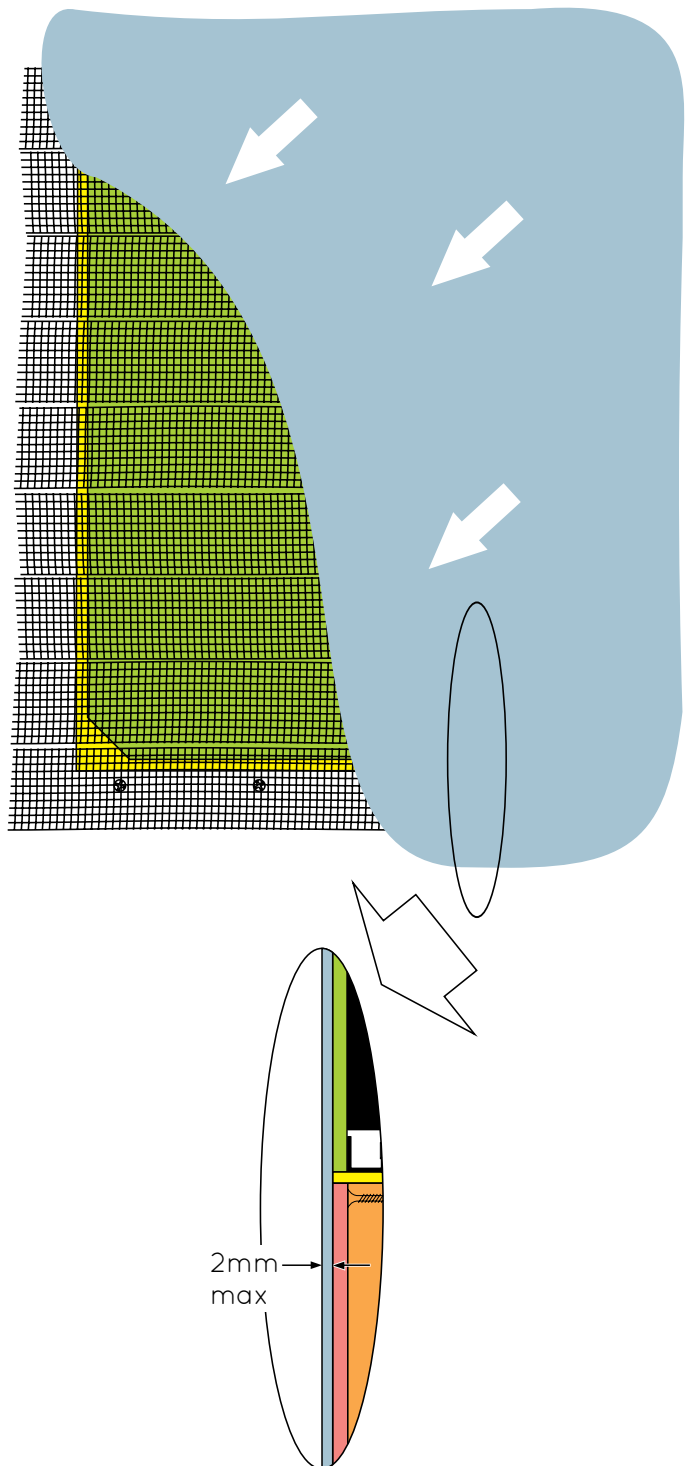

Cutaway view

This cutaway view shows a section through the finished skim in the area shown.

CONTINUE
To Decorating.



Finishing

Patch plaster

Finishing

This method positions the speaker to be patch plastered with a 2mm ($\frac{5}{64}$ ") skim across the speaker front and blended with the existing plaster.

Amina recommend British Gypsum Gyproc joint filler, followed by a fine surface filling compound. This allows a smooth accurate finish using fine sandpaper or a wet sponge.

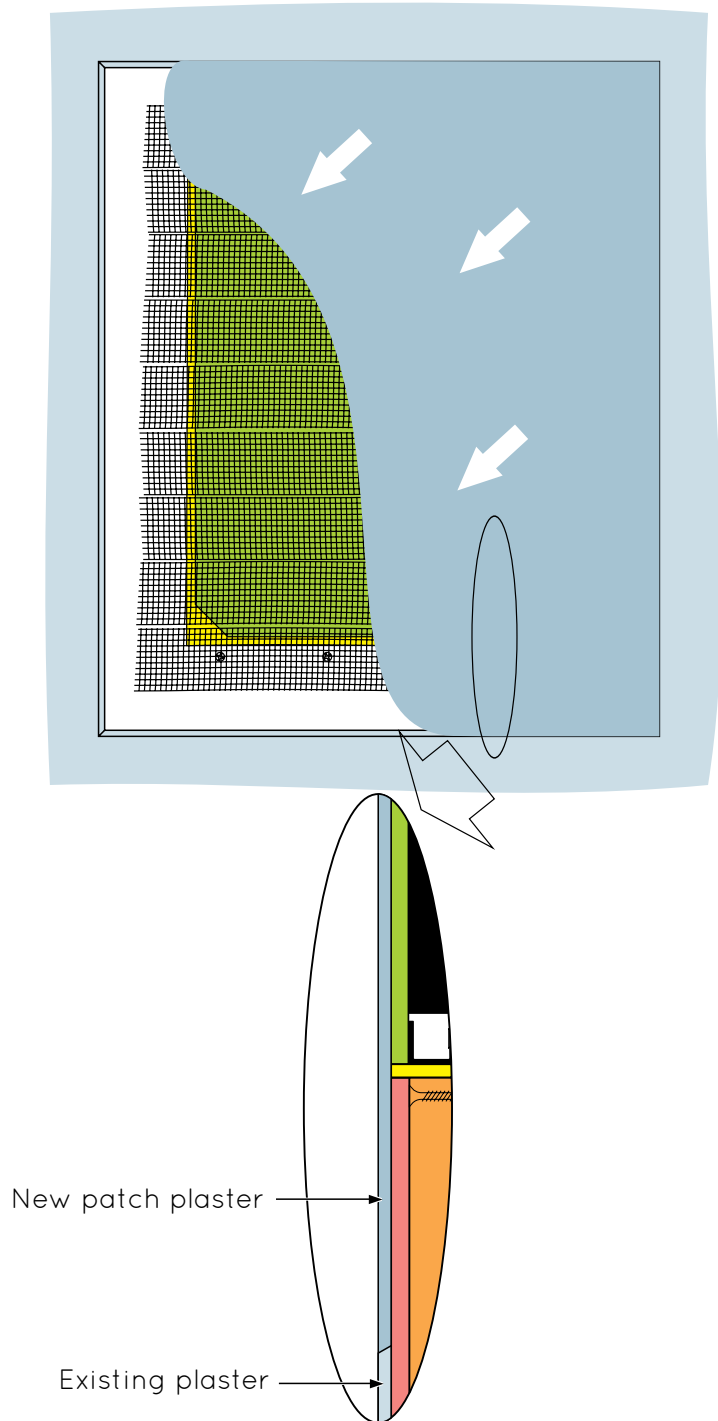

CONTINUE
To Decorating.

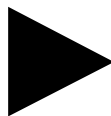

Finishing

Feather skim

Finishing

This method positions the speaker for a large area (approx. 1m² (39'')) to be skimmed over it. This 2mm (⁵/₆₄"") thick skim is then feathered outward at the edges and blended into the existing wall/ceiling finish.

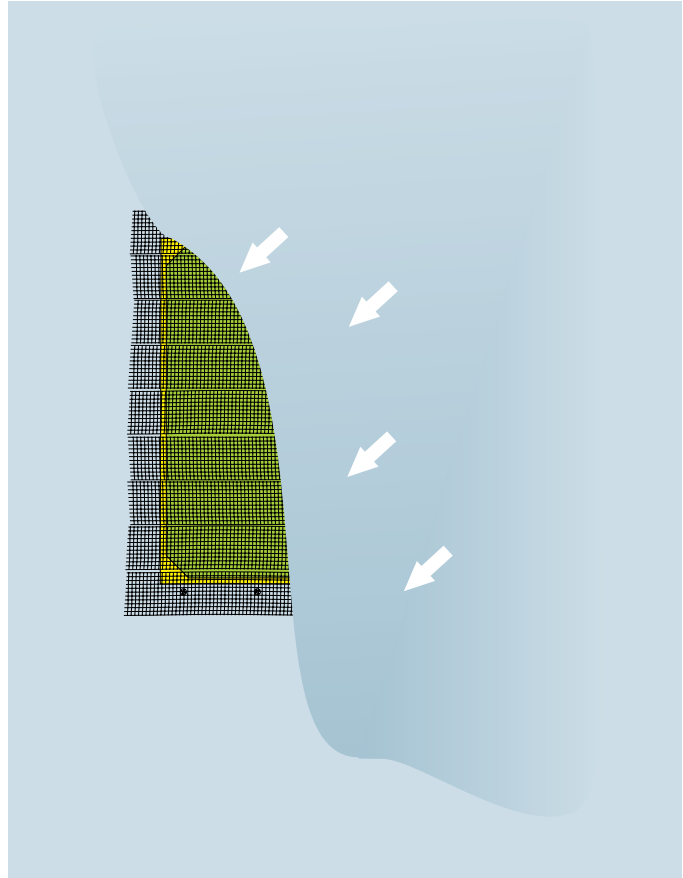

CONTINUE
To Decorating.



Decorating

Allow your plasterwork to dry completely. Test the speaker again . You can then paint the surface or hang wallpaper in the usual manner.

Amina Invisible speakers have been optimised for three coats of emulsion once plastered. Additional coats will cause very small reductions in the maximum sound pressure levels achievable.

Completed and fully dried plaster surfaces should be finished with permeable coatings / materials to allow moisture in that coating or the adhesives used to apply those materials, to dry into the environment quickly.

Oil based coatings and other non-permeable surfaces will trap moisture in the plaster surface for many days and even weeks. This has the potential to work its way back to the Amina loudspeakers exposing them to an unacceptably damp environment for an extended period.

The use of impermeable coatings and materials should be considered carefully and with caution. Bare plaster surfaces must be pre-treated with a primer / sealing coat that is permeable during its drying process. The entire surface and the entire building environment must then be fully dry (this may take some weeks) before applying the impermeable coating or material.

Maintenance and cleaning

Once your speaker is plastered into your wall or ceiling, it requires no physical maintenance. Your wall or ceiling can be cleaned with products appropriate to the finish finally applied to the plaster surface.

The wall or ceiling can be painted or redecorated any number of times. Extreme care should be taken when removing wallpaper type coverings to ensure the plaster surface is not damaged. If damage to the plaster work occurs, use repair plaster to restore the plaster surface prior to re-decorating. Amina Technologies Ltd recommends British Gypsum Gyproc-Joint-Filler.

Avoid pushing the wall or ceiling surface immediately in front of the speaker. Excessive excursion, whilst unlikely to damage the speaker, will undoubtedly cause the plaster to crack around its perimeter.

Accessories

Subwoofers

ALF40

40W compact, passive bass enhancer with unique adjustable port design allowing the product to be installed within joinery, behind kick boards or within ceilings or other voids.

Highly discreet, high quality bass enhancement is achieved with only a small opening for the port required within the room.

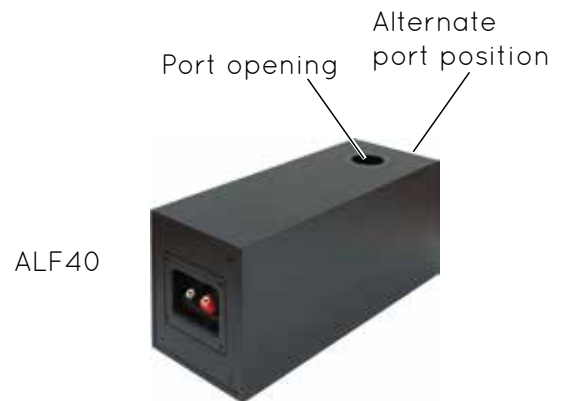

ALF80

150W passive subwoofer with unique adjustable port design allowing the product to be installed within joinery, behind kick boards or within ceilings or other voids. Highly discreet, powerful and deep bass response is achieved with only a small opening for the port required within the room.



ALF120

Amina have developed an astonishing subwoofer technology dubbed 'distributed transmission line' (DTL), which allows the design of a subwoofer thin enough to be built into a stud wall, venting through a simple slot in the skirting board, to create an impressively low 27Hz audio output at 111dB loudness using only 50W of power.

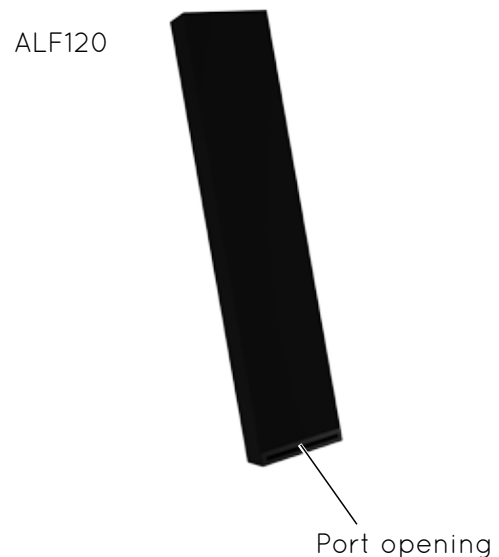

Troubleshooting

Thorough testing of the loudspeakers should be carried out both prior to and after plastering to avoid time consuming repairs or modifications at a later stage. Should you encounter any problems at either of the test stages the following guide is designed to help determine possible problem areas.



CAUTION:

Do not use a battery or DC voltage supply to check continuity or phase check as there is no forward or backward movement of the panel.

DC voltage can damage the speaker.

Advice for testing

- When testing always use a basic sound system (amp, source, loudspeakers) to eliminate the possibility of faults with other, more sophisticated components, such as control systems.
- Test at low and medium volumes and be careful not to exceed the specific speaker model's recommended power. Using tone sweeps or music as test material, listen for distortion, buzzing or rattles at appropriate levels. Using test discs or music, confirm that all channels are in-phase.
- Ideally, professional test equipment should be used to record a full frequency response of the loudspeaker before and after plastering.

No or low sound output

- Check continuity of all cables.
- Check that all cables and connections are made correctly, are intact and that all channels are correctly phased (+ to + and - to - from amp to speaker).
- Using an impedance meter, check the nominal impedance of the speaker (APU must not be connected) both at the speaker and the amplifier end of the cable. Do these measurements match each other? (Allowing for the small impedance increase of less than 1 ohm along the wire length) Do they match the stated nominal impedance on the loudspeakers specification label? If the nominal impedance does not match the product's stated impedance, a speaker driver may be open circuited or short circuited. If so, the product may need to be returned to Amina for repair or replacement.
- If the nominal impedance at the end of the cable is very different to the impedance at the speaker, check your cables. Cuts or nicks in the cable along its length can dramatically increase impedance or create a short circuit, dramatically lowering the impedance.

Troubleshooting

Distortion, buzzing or rattles at modest volumes

- Try to identify the location of the buzz or rattle. It may be caused by a loose screw or other mechanical object. Check the wall or ceiling and speaker assembly and ensure screws and fixings are tight.
- If the rattle persists, remove the speaker from the wall and check your wiring to the product. Ensure that wires, with the speaker in the final location, are not resting against the speaker or backbox (if used), causing rattles.
- With no audio signal applied, lightly push the speaker face in and out at its centre. Listen carefully for rubbing on the driver, which may sound like scratching. This may indicate the speaker has been over driven and subsequently damaged. The speaker will need to be sent to Amina for repair or replacement.

Very low output after speaker passes electrical tests

- With no audio signal applied, lightly push the panel in and out at its center. Listen carefully for rubbing voice coils on the driver, which may sound like scratching. This may indicate the speaker has been over driven and subsequently damaged. The speaker will need to be sent to Amina for repair.

Distortion at higher volume levels

- Diffuse source panel loudspeakers of this type have an extremely fast response, articulating the signal from your audio system very accurately. Take your system back to the bare minimum (amplifier, source and loudspeakers) to eliminate distortions introduced by other components.
- When using your amplifier at maximum power levels, or if the input of your amplifier is being overloaded, the signal level may be 'clipping'. With some conventional loudspeakers this may not be evident, but with a diffuse source panel speaker you are much more likely to hear the distortion. Consider adjusting or upgrading your system.

Specifications

Mobius series - Plaster over products

Model number	Mobius5	Mobius7	Mobius Dual
Dimensions	450mm x 345mm x 31mm (17 ³ / ₄ " x 13 ⁵ / ₈ " x 1 ¹ / ₄ ")	450mm x 345mm x 31mm (17 ³ / ₄ " x 13 ⁵ / ₈ " x 1 ¹ / ₄ ")	450mm x 345mm x 35mm (17 ³ / ₄ " x 13 ⁵ / ₈ " x 1 ³ / ₈ ")
Weight	1.32kg (2lbs 15oz)	1.78kg (3lbs 15oz)	2.1kg (2lbs 15oz)
Nominal impedance	4Ω	4Ω	2 x 8Ω
Frequency response	65Hz - 30kHz	55Hz - 30kHz	105Hz - 30kHz
Sensitivity (@ 1m/2.83Vrms)	86dB	87dB	87dB
In-line protection unit (single channel)	APUi50C	APUi70C	2 x APUi30C
In-line protection unit (multi-channel)	APU-RS8iC/ APU-RS16iC	APU-RS8iC/ APU-RS16iC	APU-RS8iC/ APU-RS16iC
Fixing options	Amina BackboxCV345 / BackboxSW345 / Basic fixing kit / Firehood345	Amina BackboxCV345 / BackboxSW345 / Basic fixing kit / Firehood345	Amina BackboxCV345 / BackboxSW345 / Basic fixing kit / Firehood345
Power handling (continuous)	50W	75W	2 x 30W
Power handling (peak)	100W	150W	2 x 60W
Operating temperature range	16°C - 40°C	16°C - 40°C	16°C - 40°C
Manufacturer limited warranty	10 years (residential systems), 5 years (commercial systems)	10 years (residential systems), 5 years (commercial systems)	10 years (residential systems), 5 years (commercial systems)

iQ series - Plaster over products

Model number	iQ1	iQ2	iQ3
Dimensions	400mm x 300mm x 31mm (15 ³ / ₄ " x 11 ⁷ / ₈ " x 1 ¹ / ₄ ")		
Weight	0.83kg (1lb 13oz)	1.08kg (2lbs 6oz)	0.92kg (2lbs)
Nominal impedance	8Ω	2 x 8Ω	8Ω
Frequency response	112Hz - 20kHz		
Sensitivity (@ 1m/2.83Vrms)	83dB	86dB	84dB
In-line protection unit (single channel)	APUi10C	APUi10C x 2	APUi30C
In-line protection unit (multi-channel)	APU-RS8iC/ APU-RS16iC		
Fixing options	Amina BackboxCV300 / BackboxSW300 / Firehood300		
Power handling (continuous)	15W	2 x 15W	30W
Power handling (peak)	30W	2 x 30W	60W
Operating temperature range	16°C - 40°C		
Manufacturer limited warranty	10 years (residential systems), 5 years (commercial systems)		

Fire resisting installation

Fire resisting installation is generally required in multi-level buildings such as offices, apartments and flats where the ceiling and any fittings in the ceiling must maintain a 60 minute barrier to fire.

The standard installations described in this guide for Amina Mobius and iQ series invisible speakers will not meet the requirements of an installation that requires fire resistance.

If an installation does require fire resistance then it will be necessary to install commercially available fire hood type products or pre-build an appropriate plasterboard lined compartment at the rear of the loudspeaker. Alternatively consider installing Amina Edge 7 speakers which can (when specific installation instructions are followed) meet the requirements of EN1365.2:2014 without the use of an Amina fire hood.

If you are in any doubt concerning the selection or installation of Amina speakers or accessories in an installation that requires fire resistance, contact Amina Technical Support.

Warranty information

Limited Warranty:

Amina loudspeakers are designed to operate reliably for many years. Correctly installed in accordance with these instructions, Amina warrants the loudspeakers against defective materials and workmanship for a period of ten years in residential and five years in commercial applications.

At the end of the speaker's useful life and in compliance with the European directive on waste electrical and electronic equipment (WEEE), this product is to be returned to your supplier, or directly to Amina for recycling. If you have any questions please contact Amina Technologies Ltd.



* Please refer to our full warranty statement for details, available **on our website, or alternatively contact us via email.**

Important Note: This product has not been tested to European Construction Products Directive EN 54-24 and therefore must not be used in voice evacuation systems located within the European Union.

Copyright information

This document is Copyright of Amina Technologies Ltd, 2019

Gyproc-Joint-Filler is a registered trademark of British Gypsum Ltd

Amina is a registered trademark of Amina Technologies Ltd

Mobius is a registered trademark of Amina Technologies Ltd

Amina Sound is a registered trademark of Amina Technologies Ltd

Contact information

Amina Technologies Ltd

Cirrus House, Glebe Road, Huntingdon

Cambridge, PE29 7DL, UK

T: +44 (0)1480 354390

E: info@aminasound.com - general enquiries and career opportunities

E: support@aminasound.com - expert advice

E: sales@aminasound.com - sales team

W: www.aminasound.com

Registered in the UK, company no: 3656822

Amina®

THE INVISIBLE SPEAKER CO.

Audio for very smart homes®

Amina Technologies Ltd
Cirrus House, Glebe Road
Huntingdon, Cambs, PE29 7DL England
T: +44 (0)1480 354390
W: www.aminasound.com / E: info@aminasound.com
Copyright 2019

Plaster over loudspeakers V4.5
